

bmp

6.00in

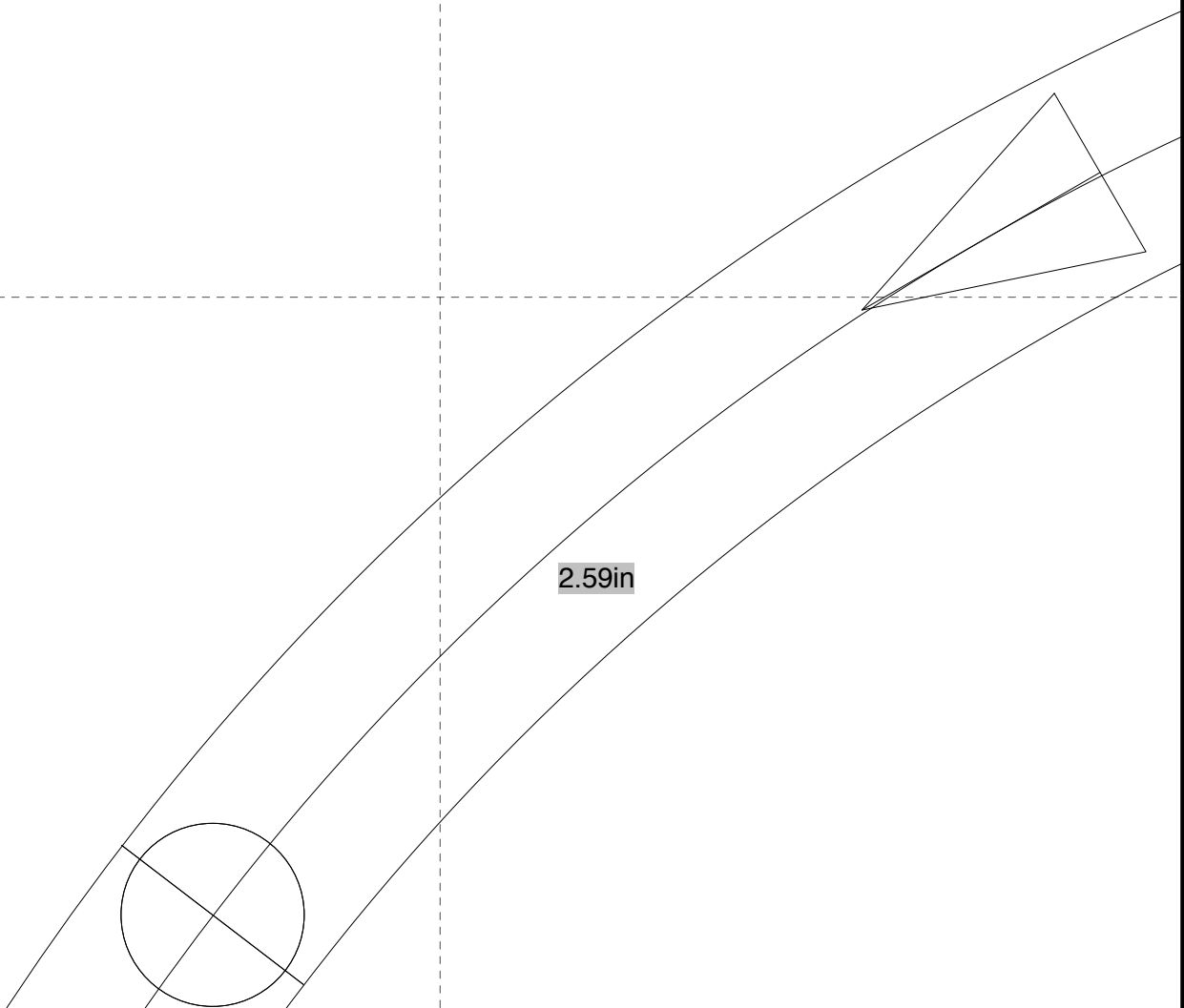

2.59in

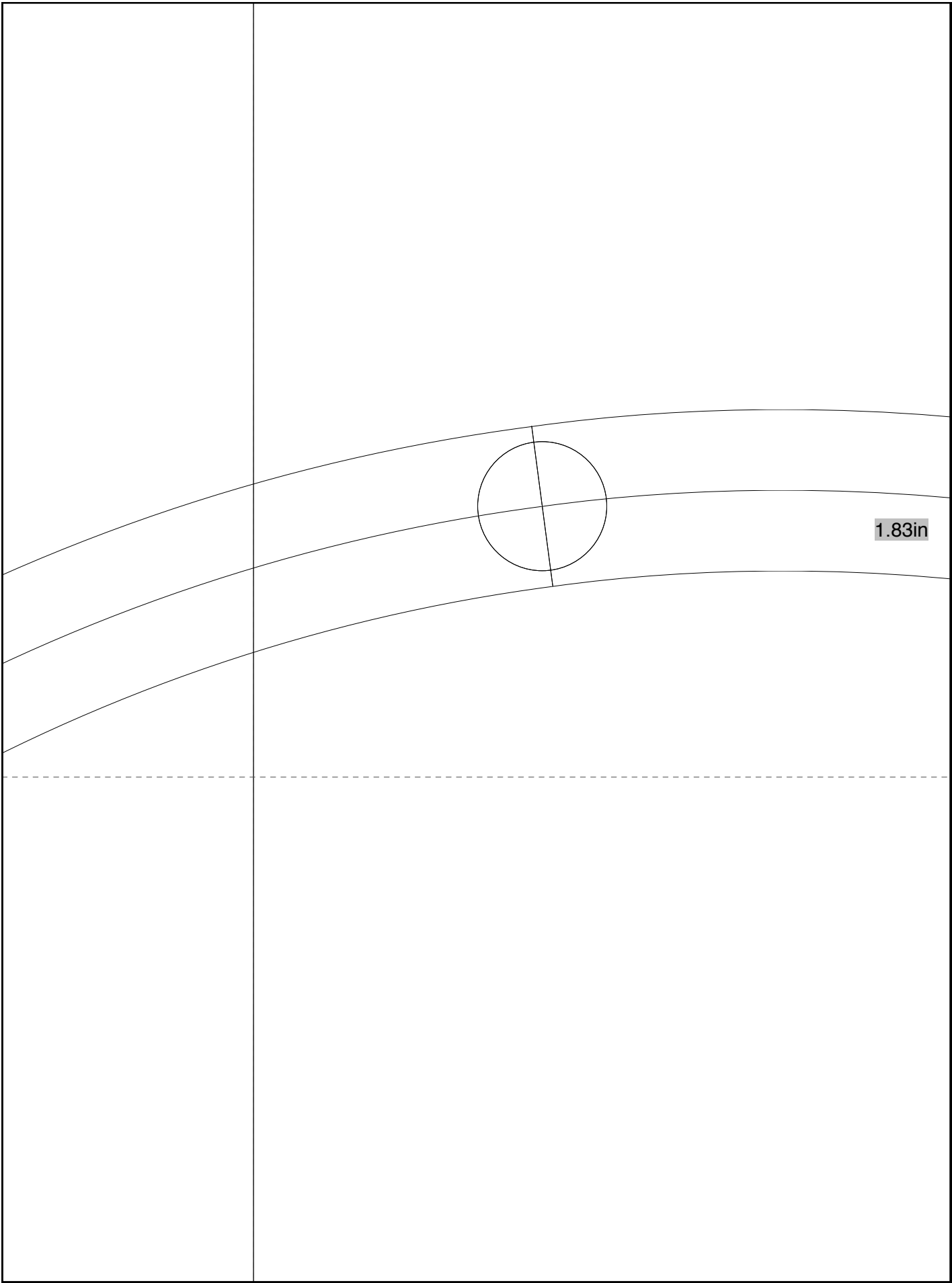

1.83in

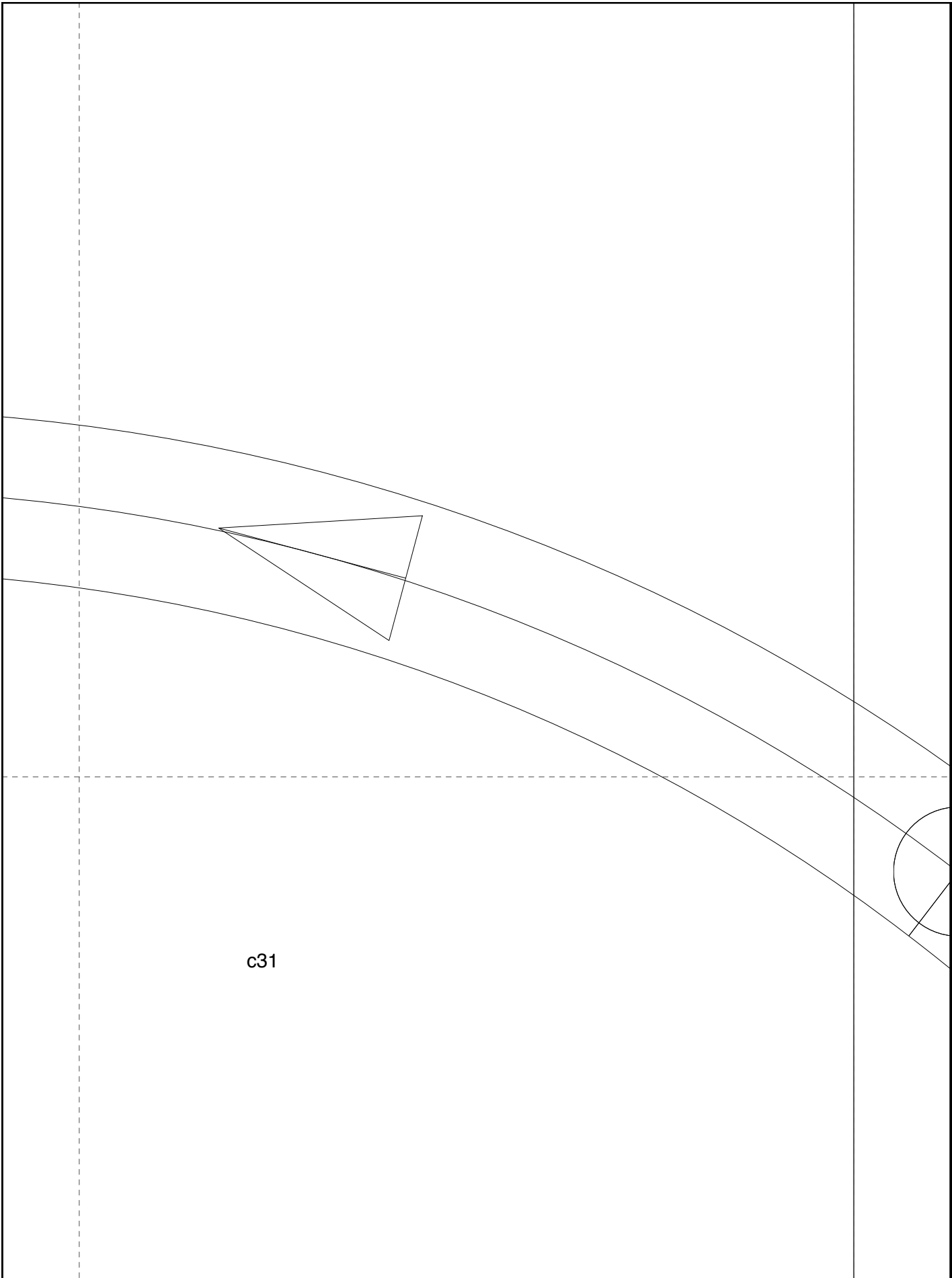

c31



1.06in

The image shows a technical drawing of a track component. It features a large right-angled triangle with a circular arc on the left side. A dimension line indicates a length of 1.06 inches. The drawing is overlaid on a grid of dashed lines. The text '1.06in' is placed within the drawing area.

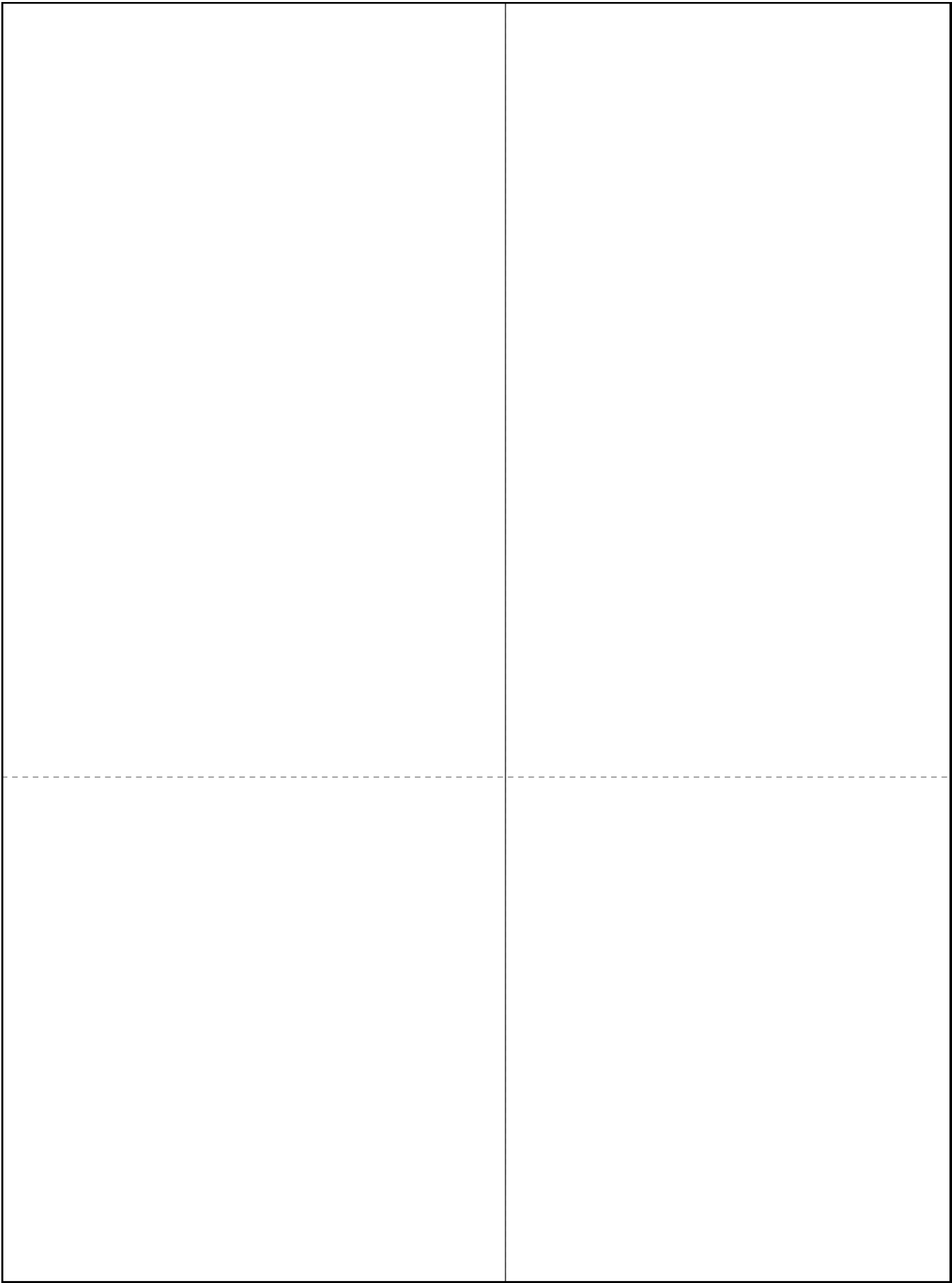

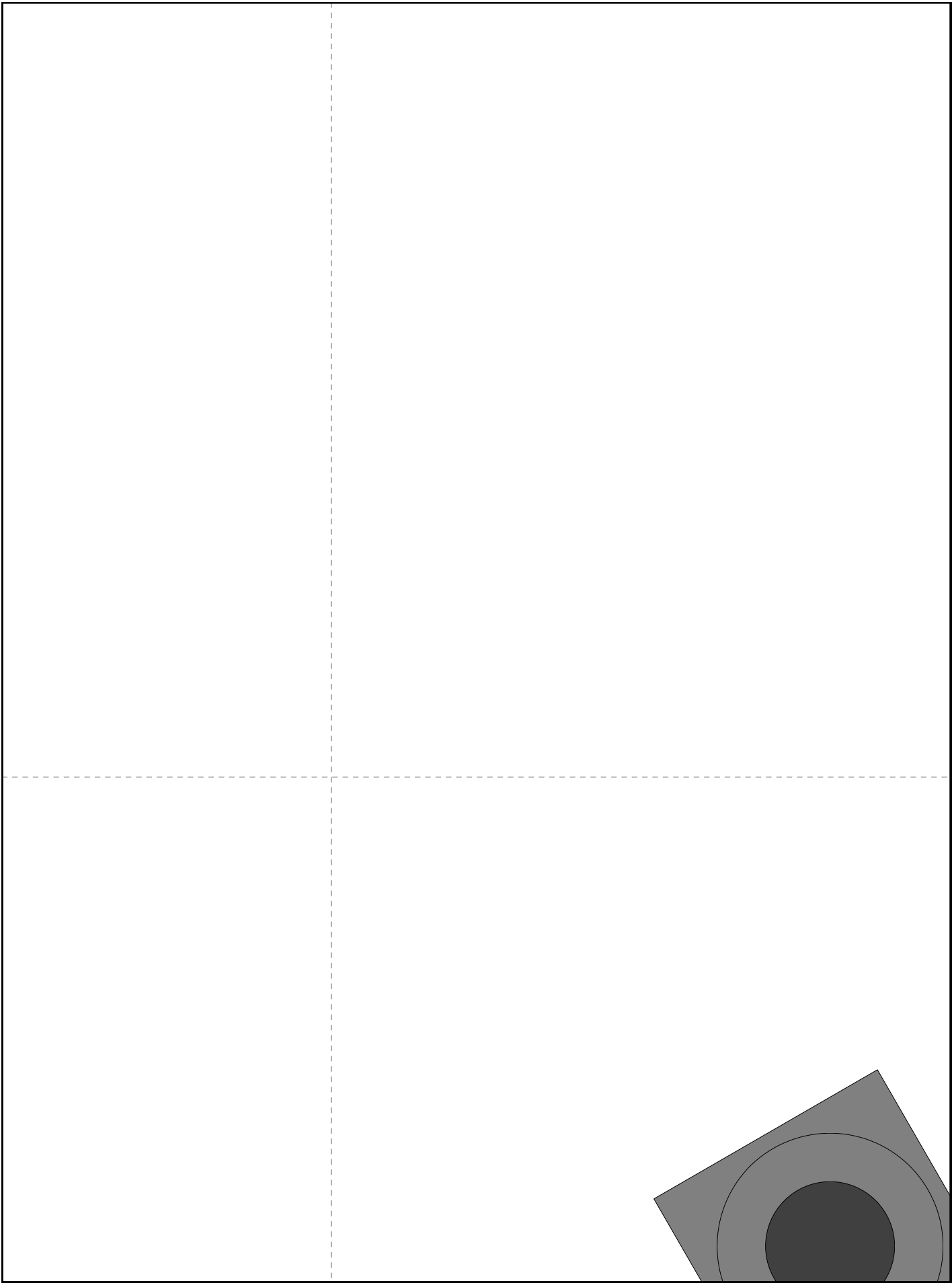



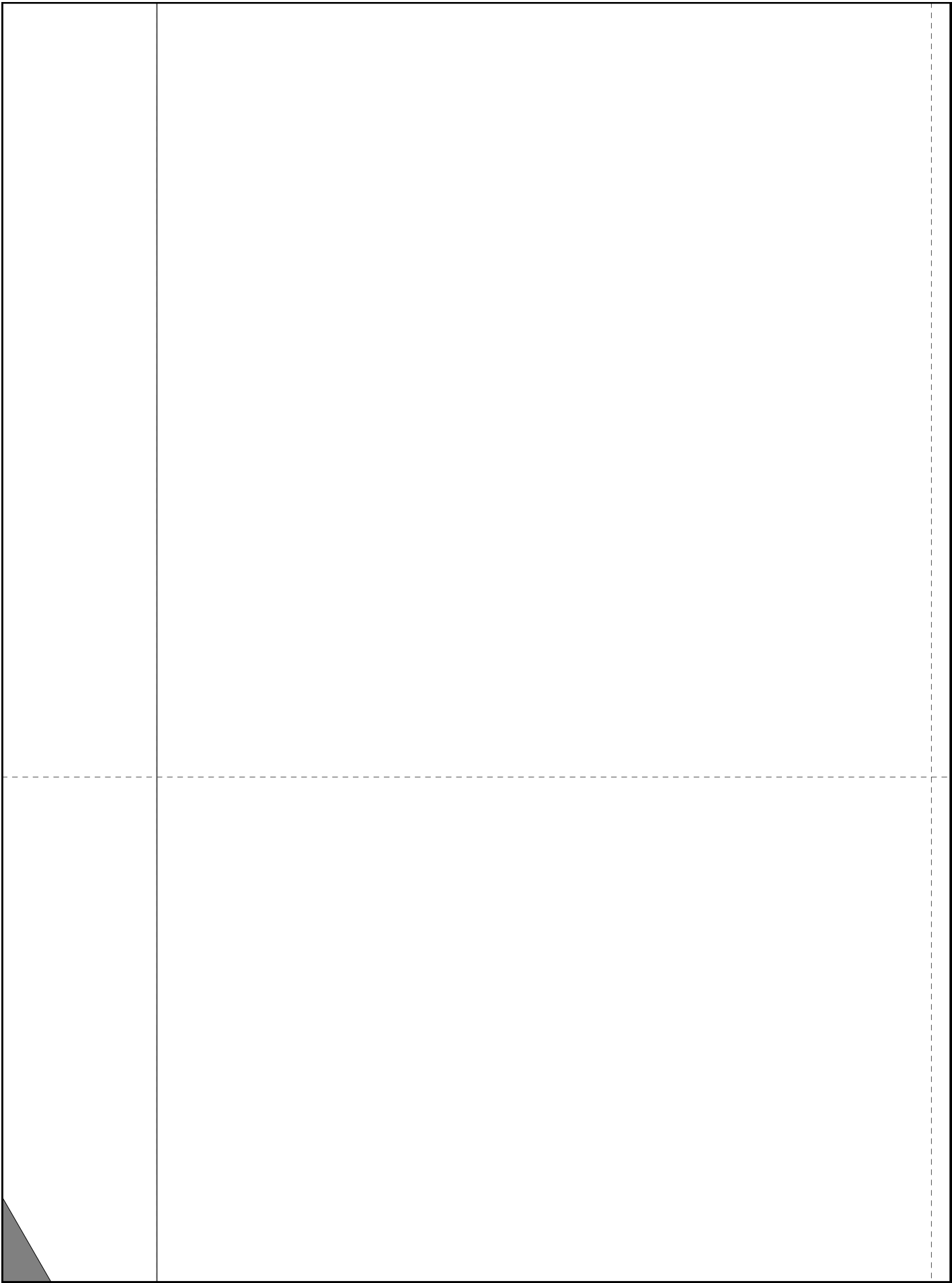

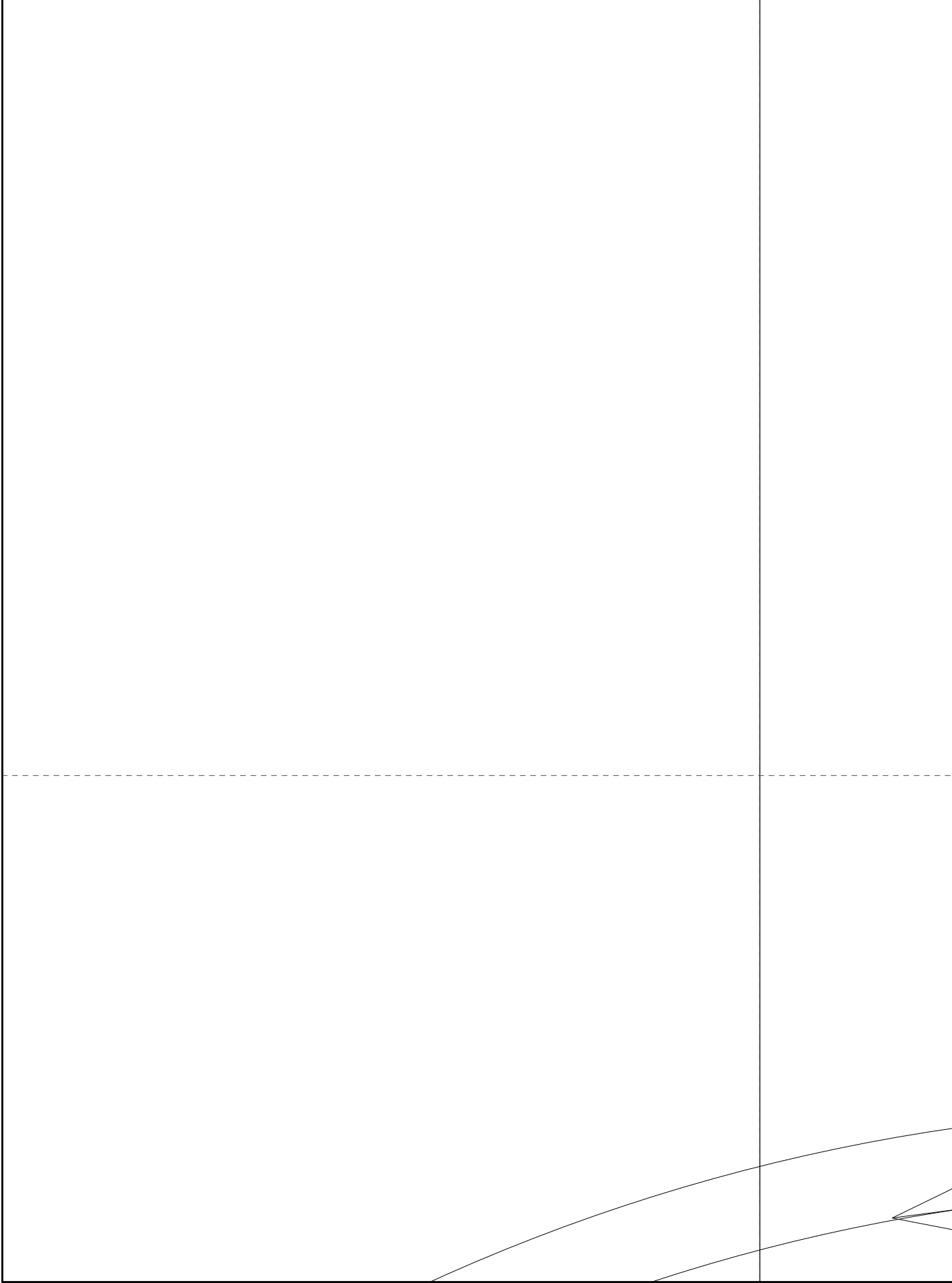

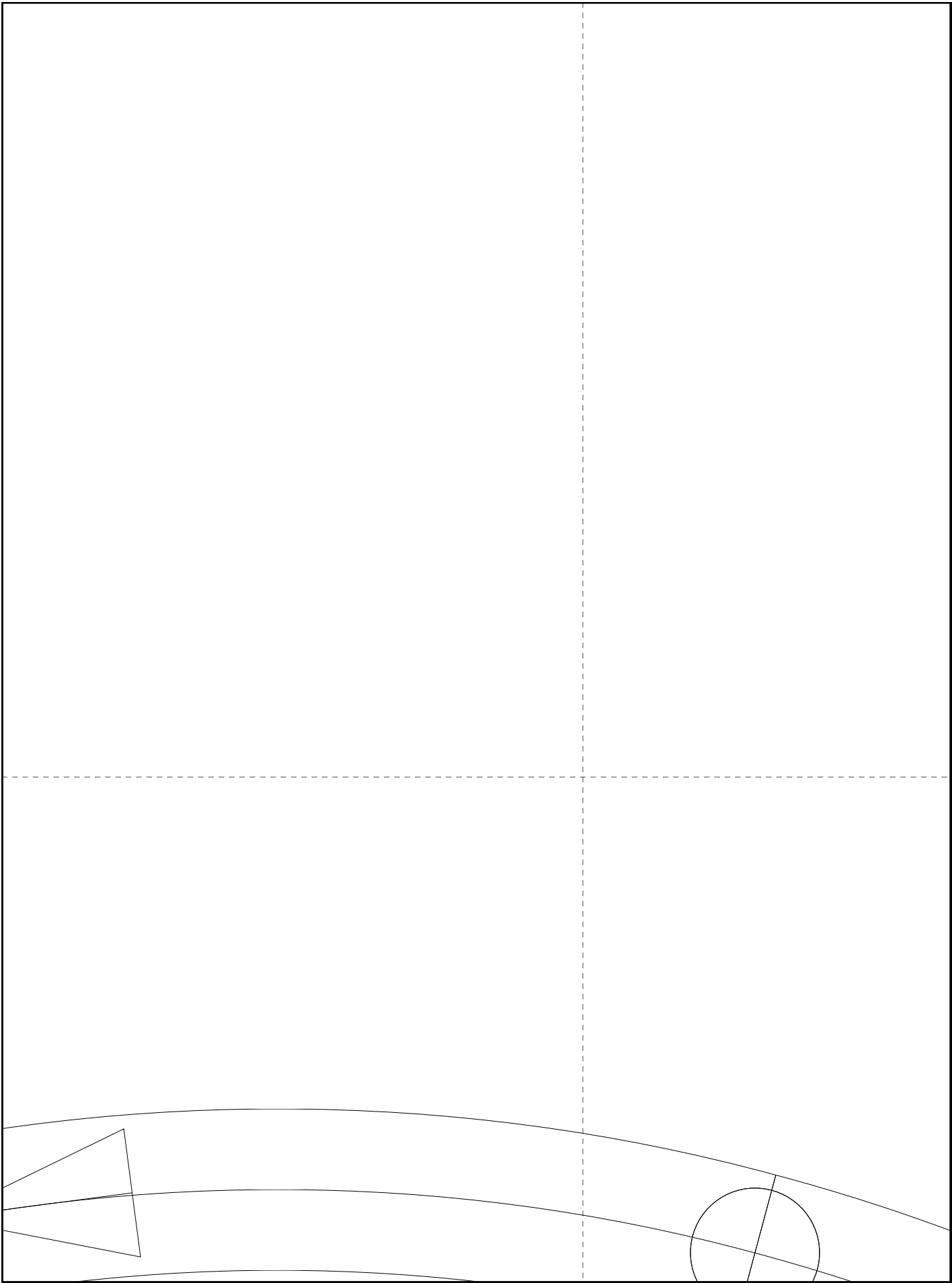

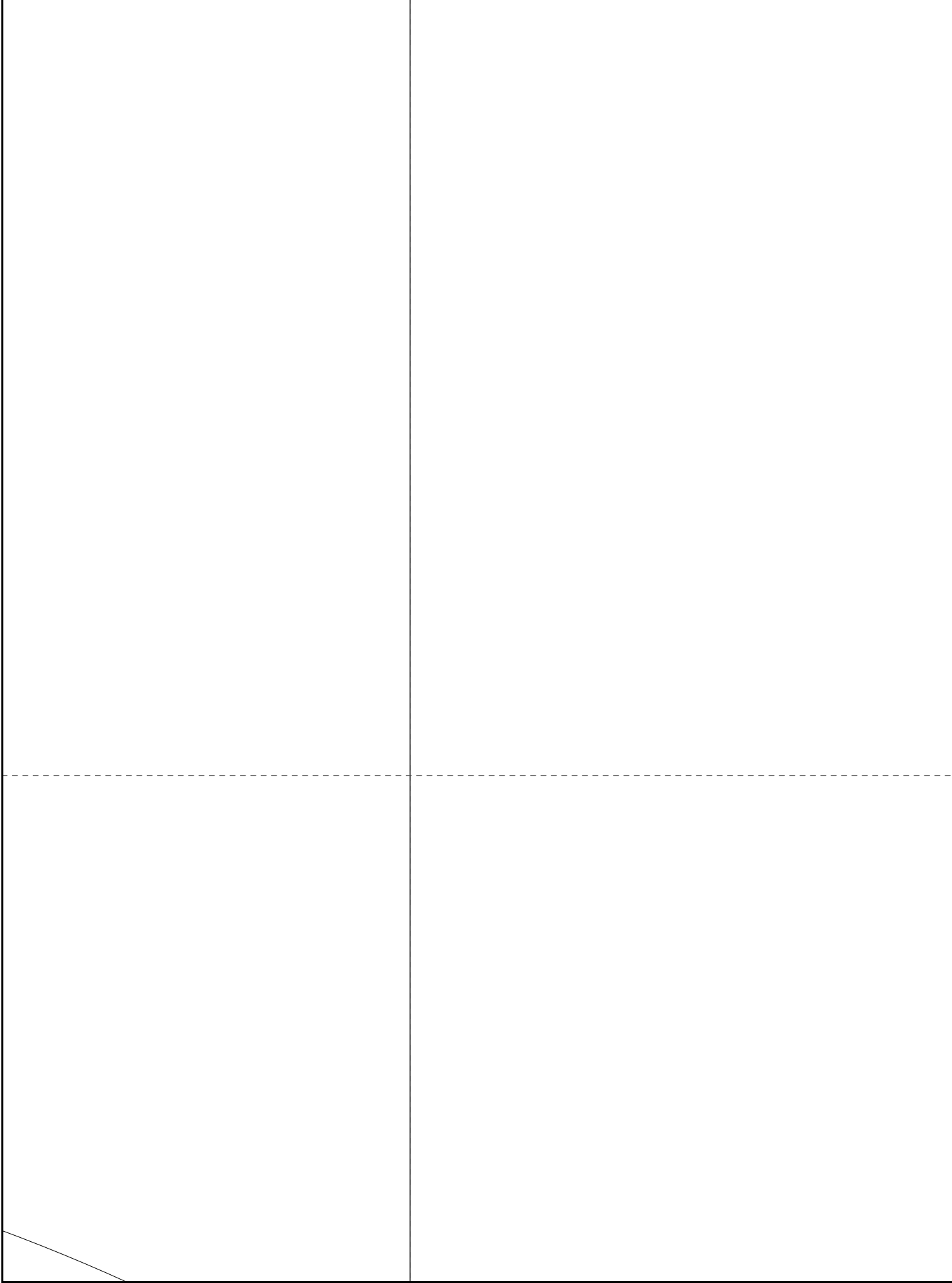

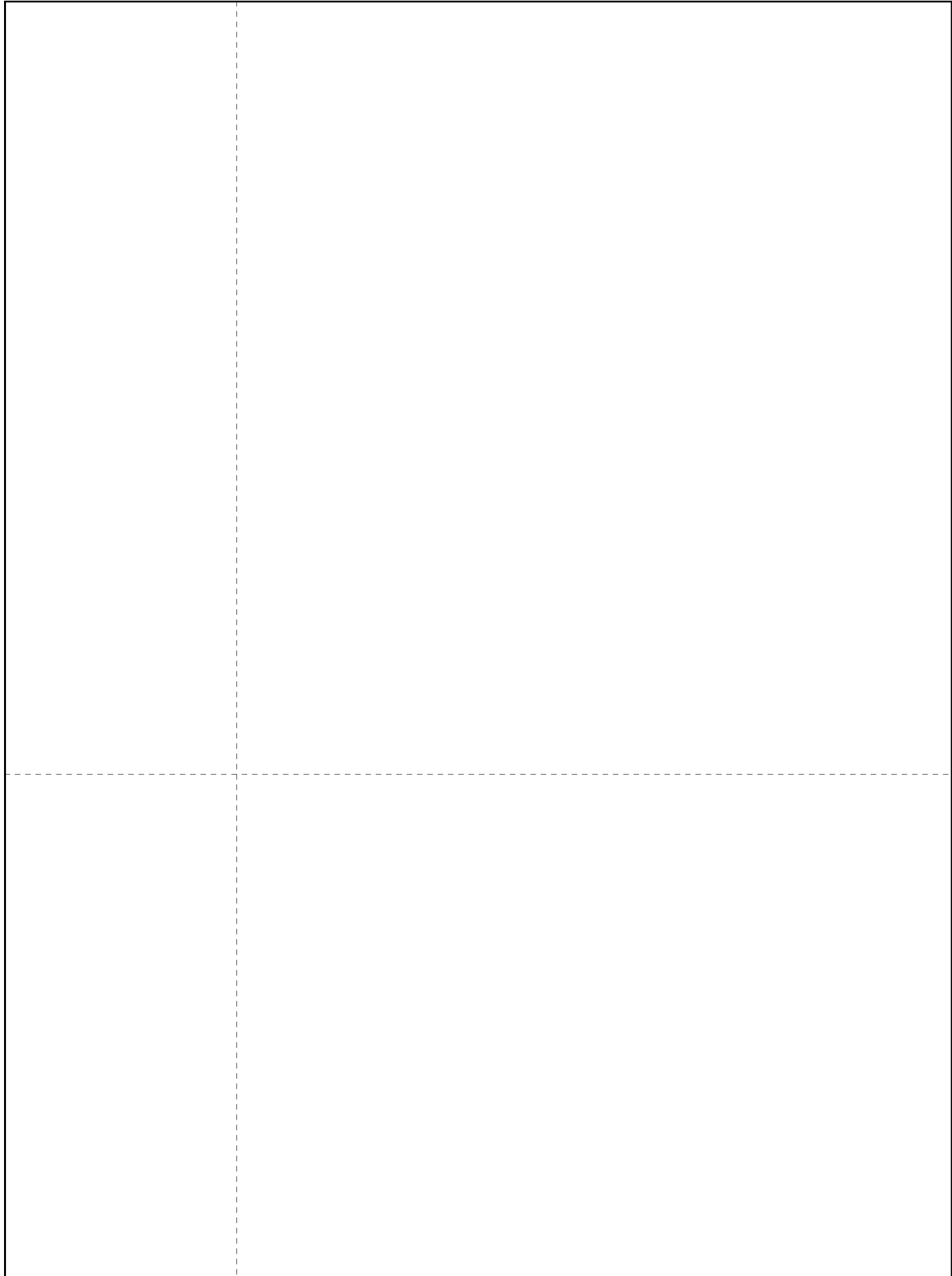

12904

6.00in

unc

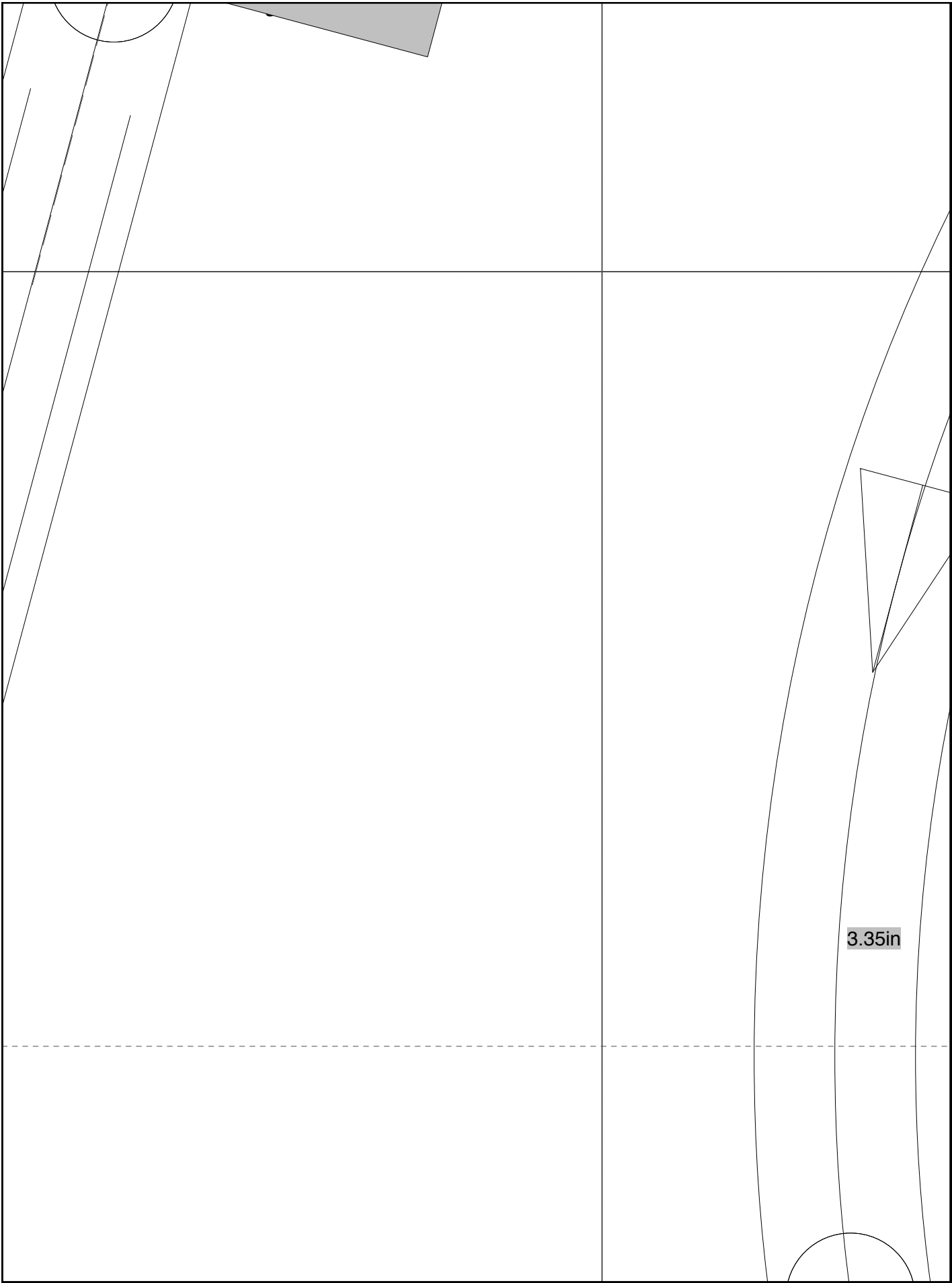

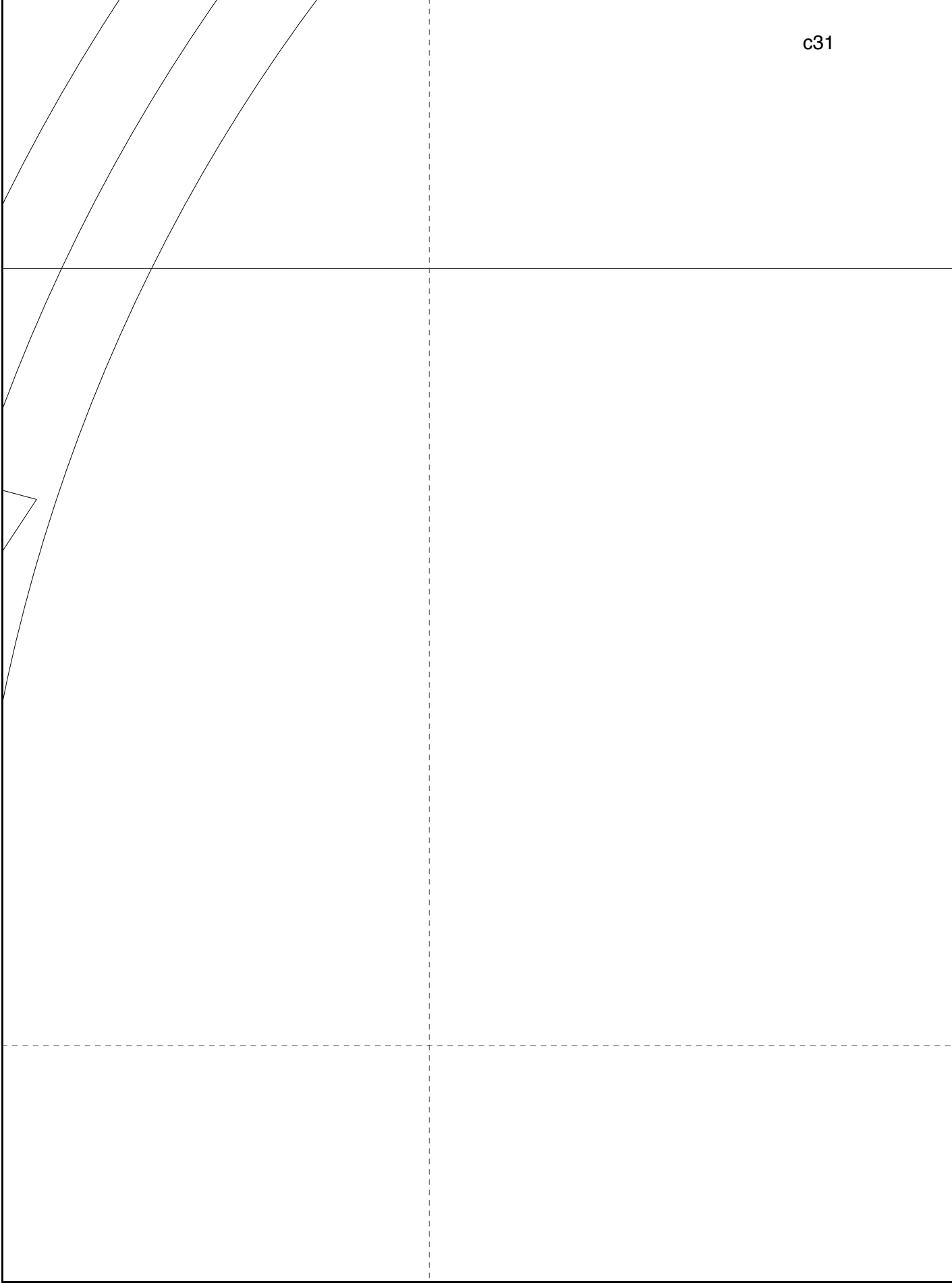



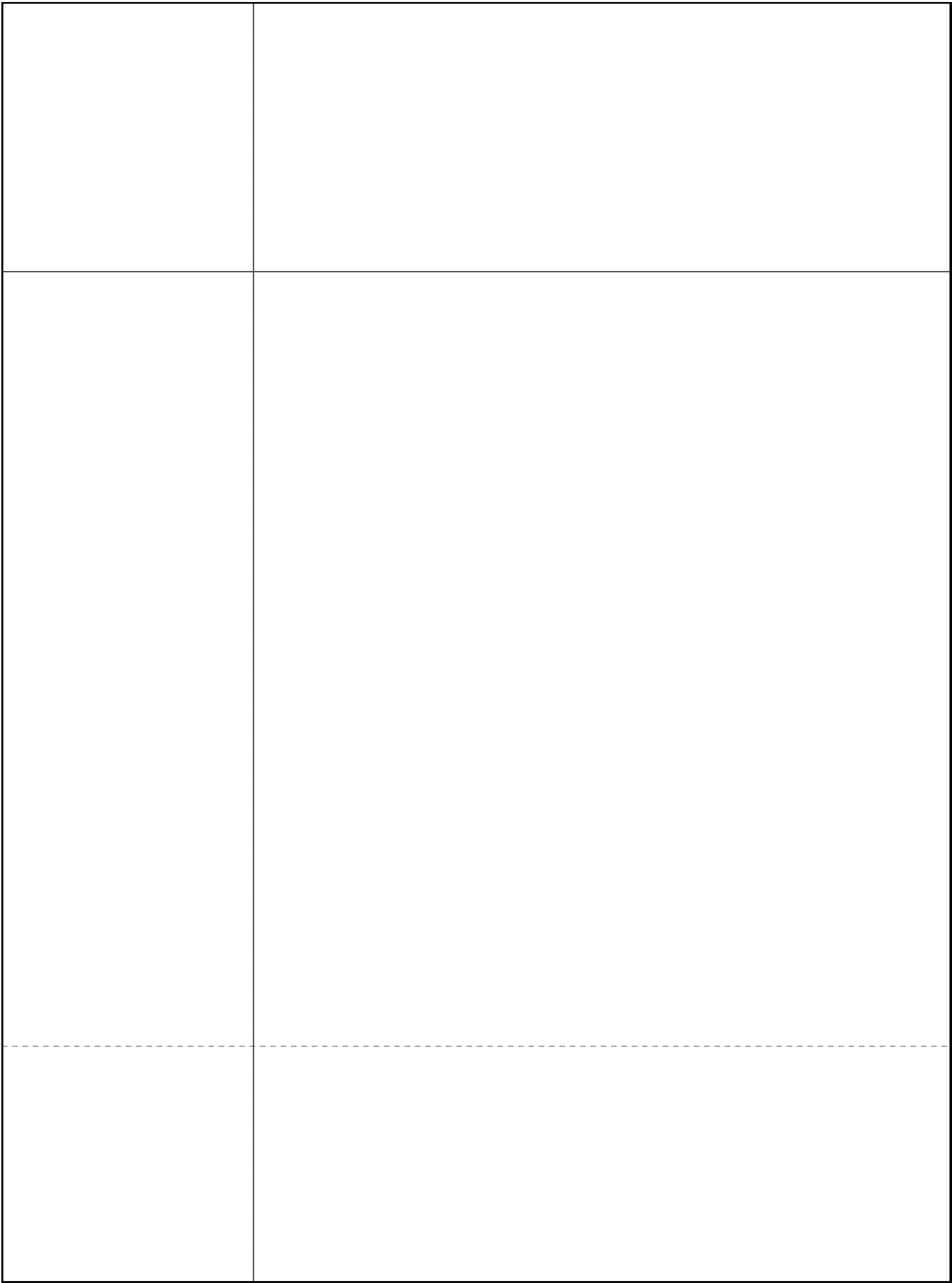

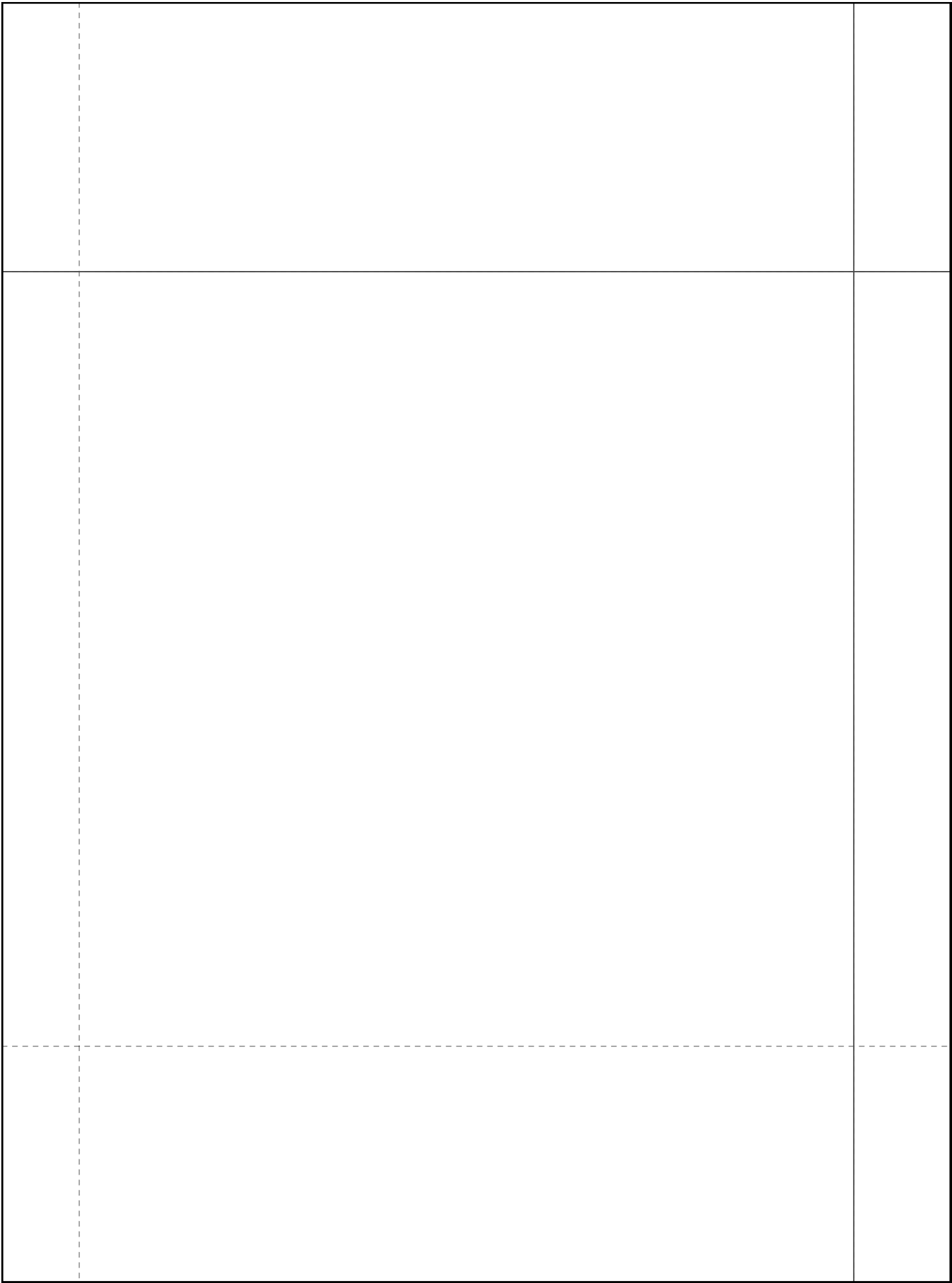

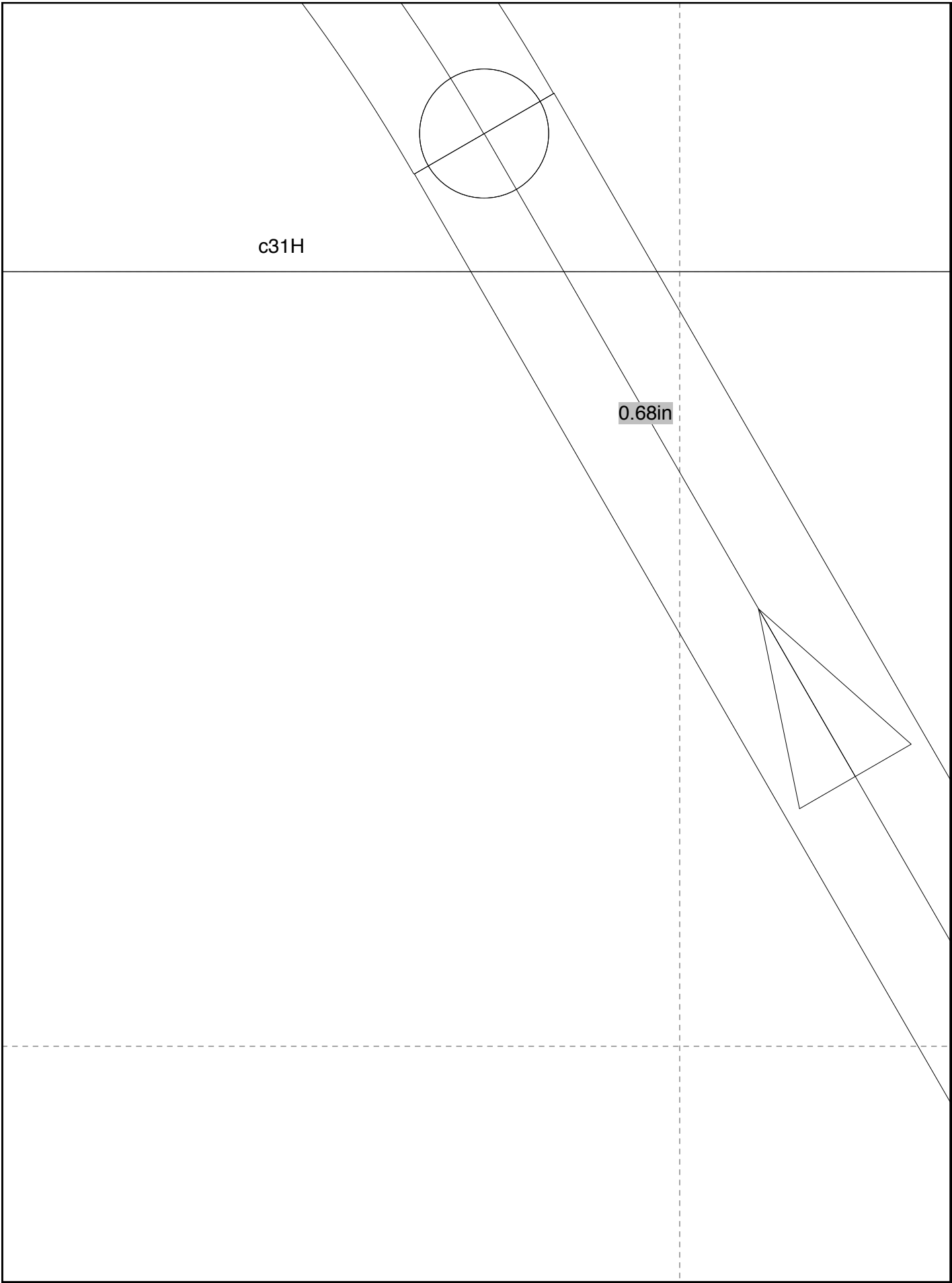

c31H

0.68in

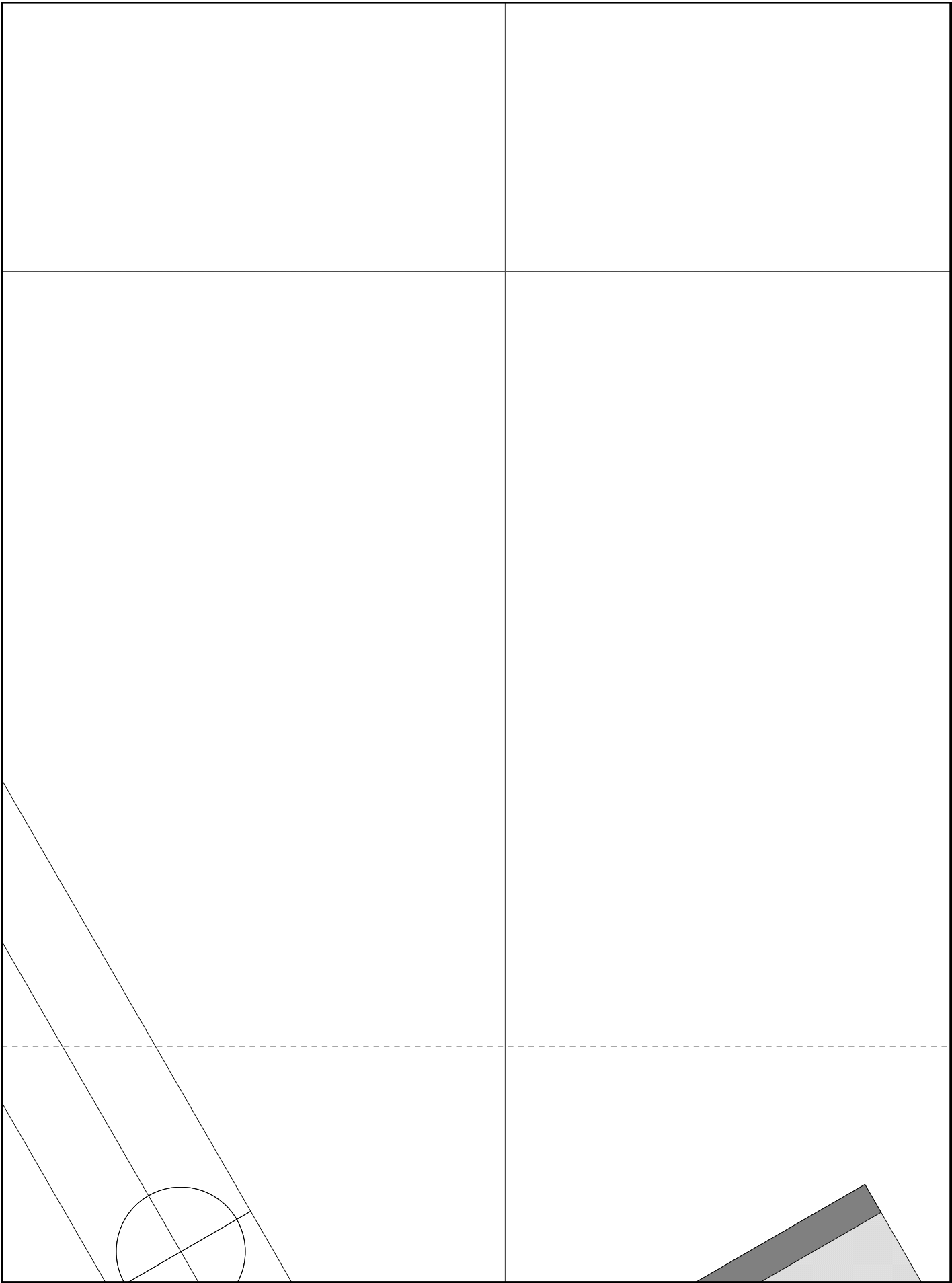

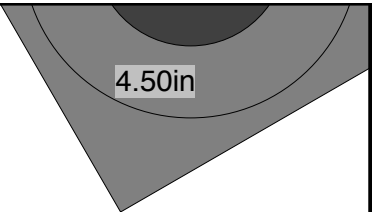

4.50in

14142

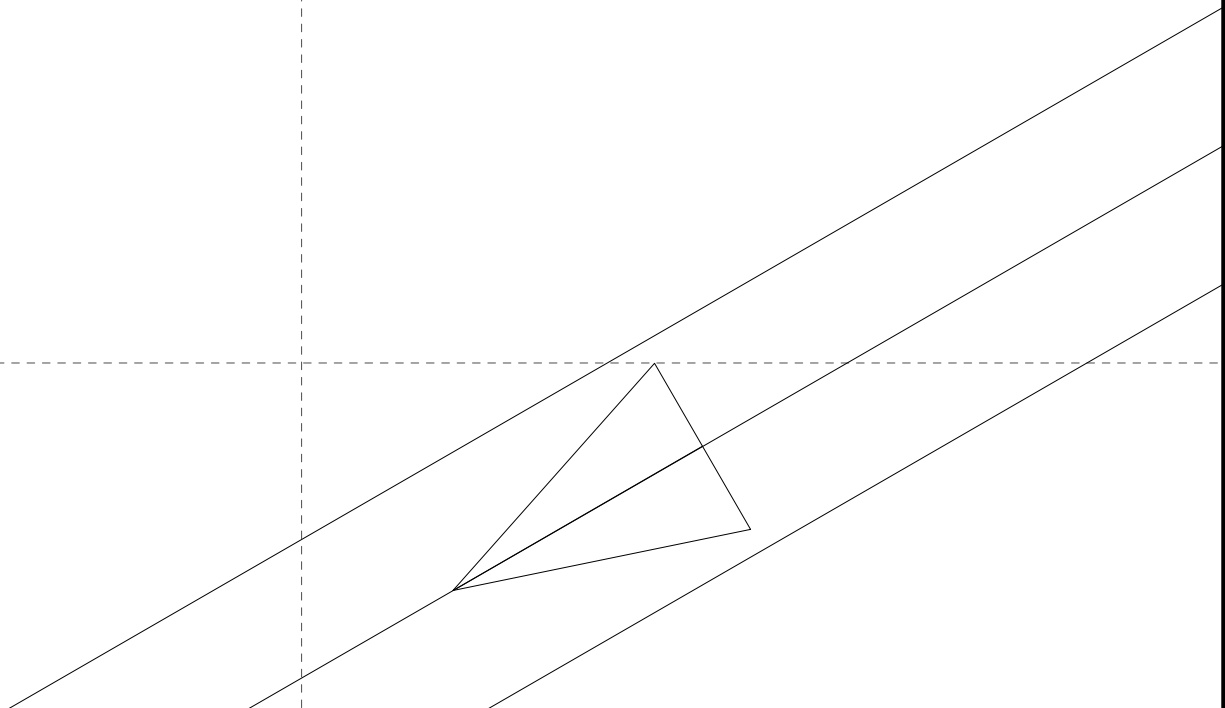

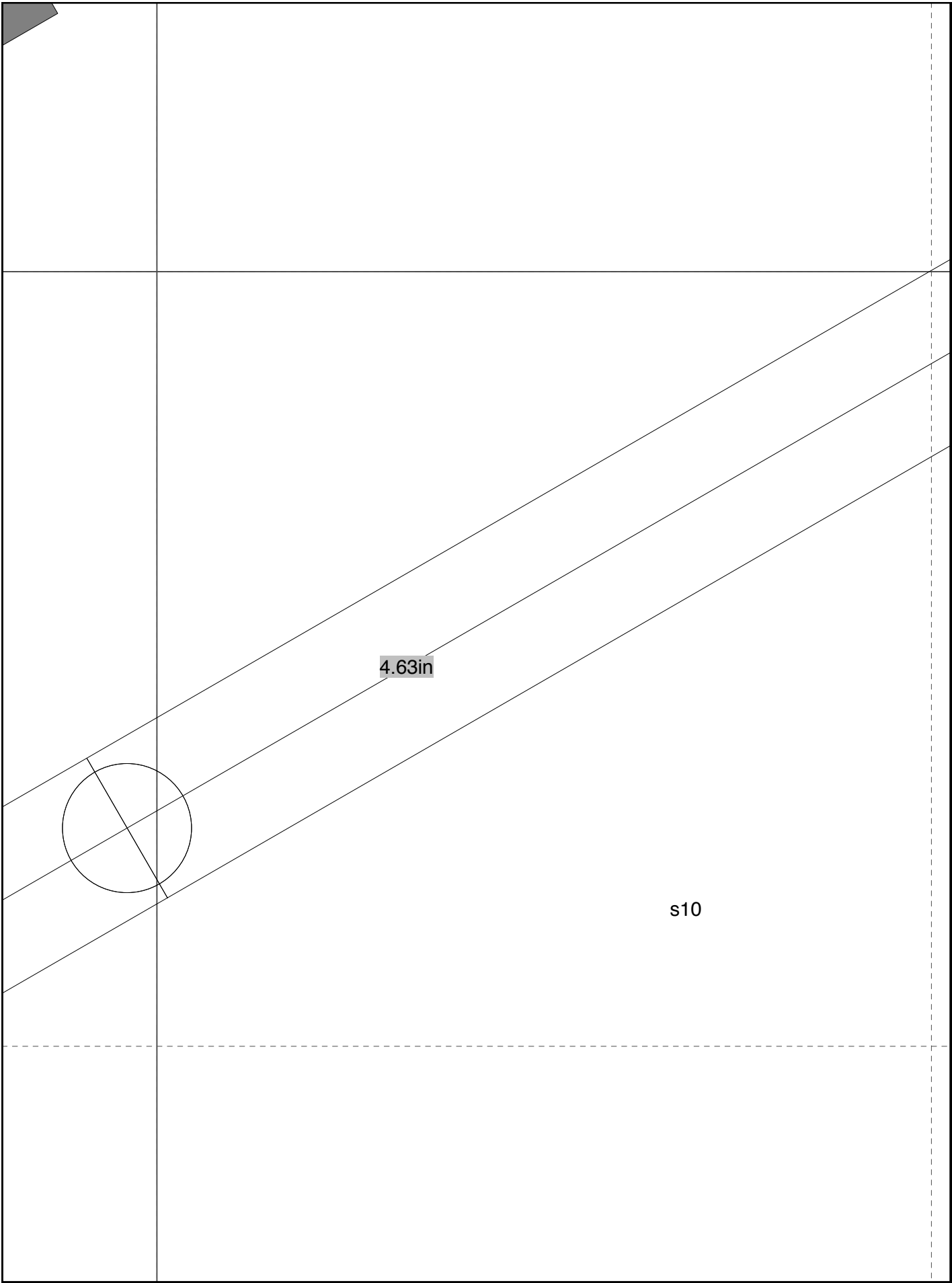

4.63in

s10

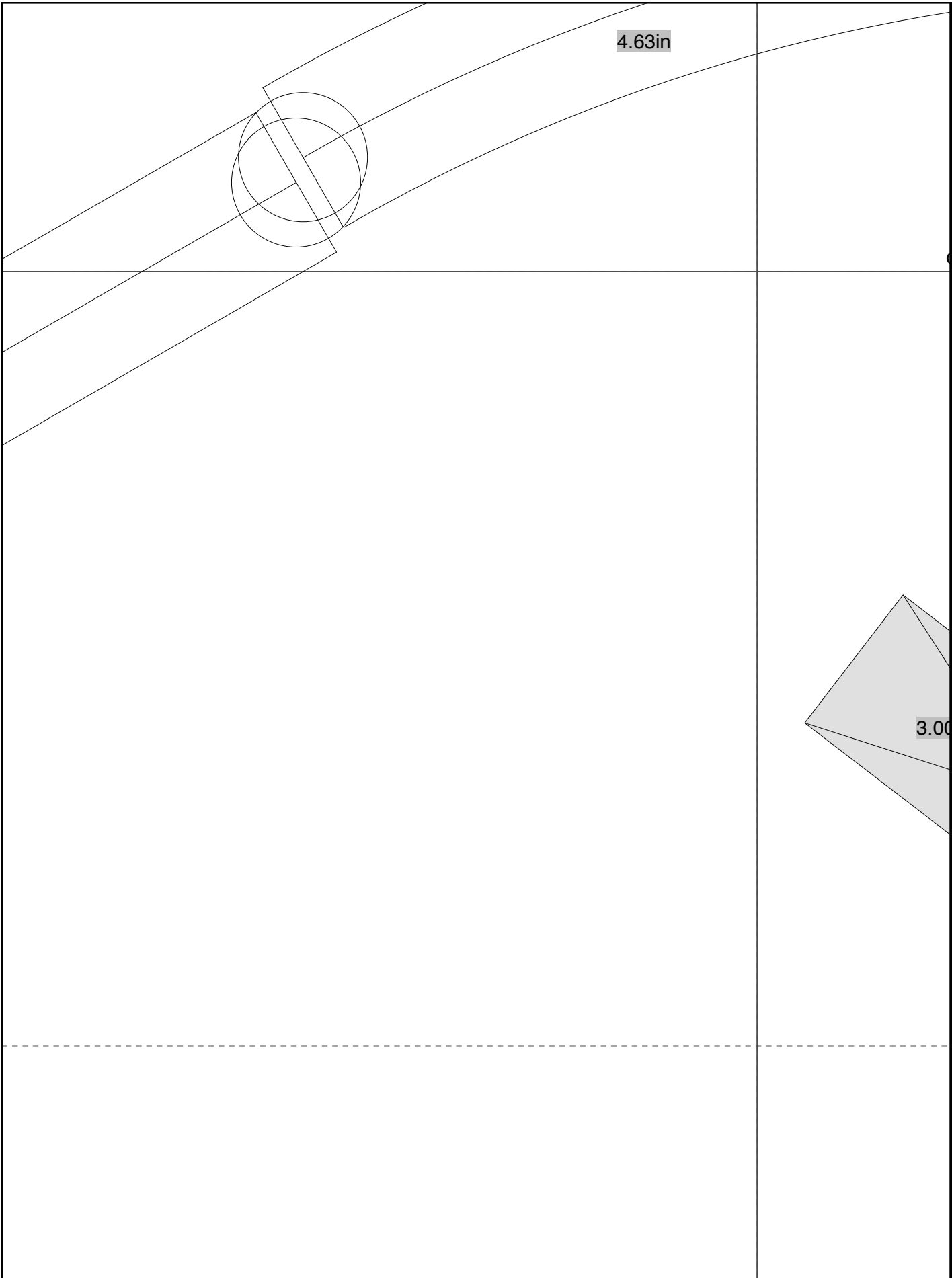

4.63in

3.00

31

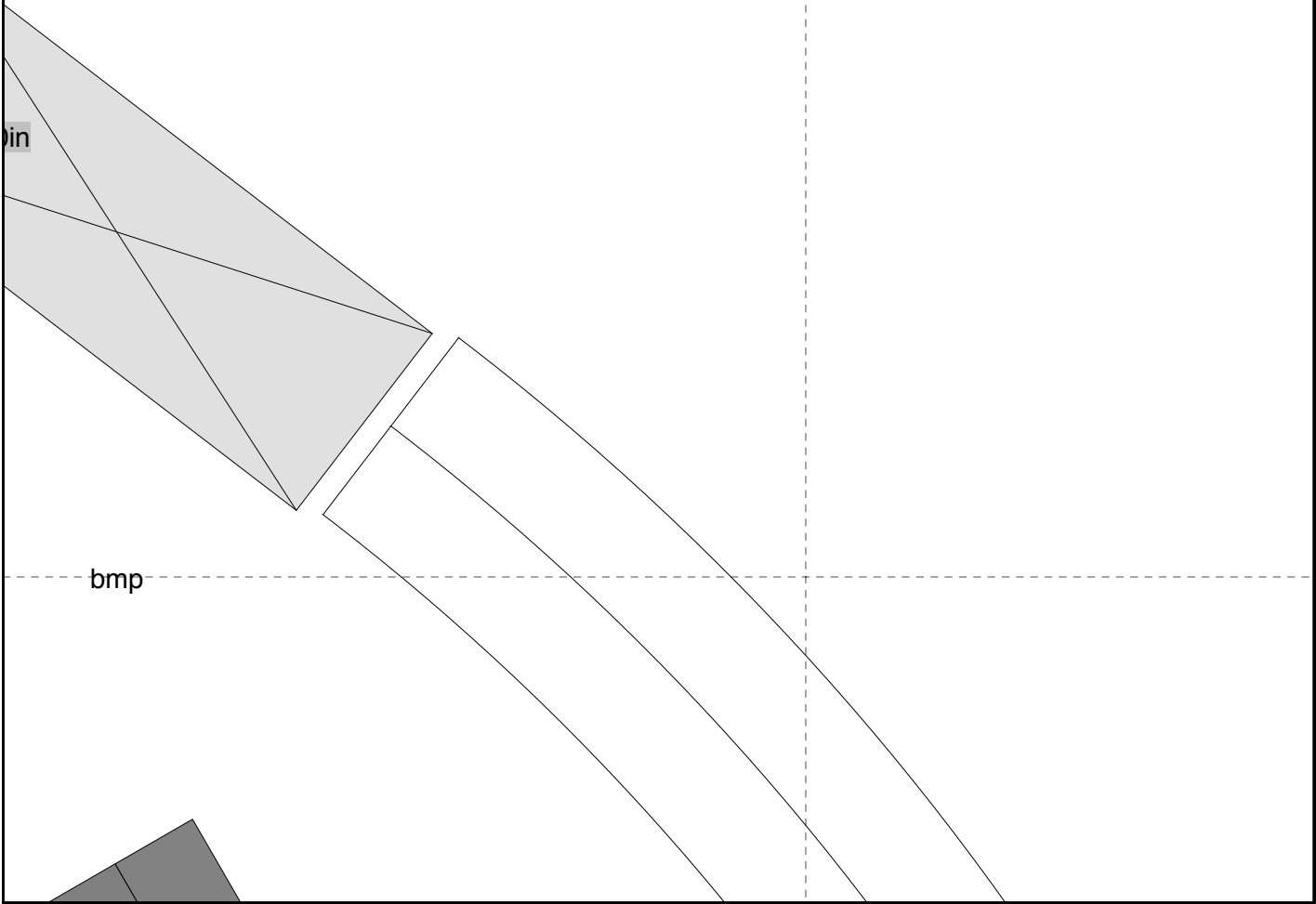



4.09in

c31

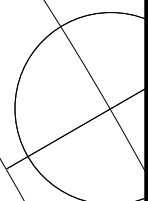

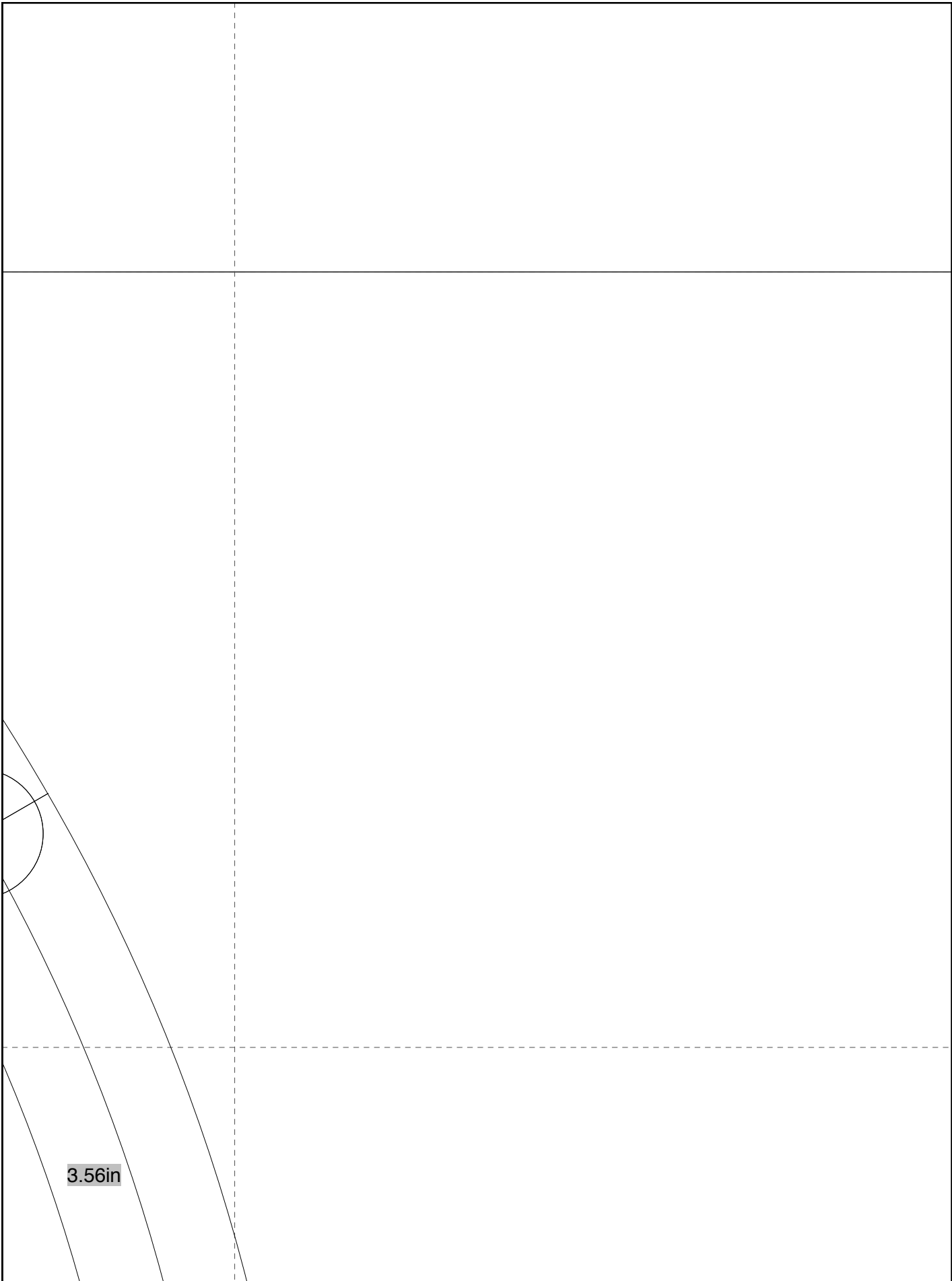

3.56in

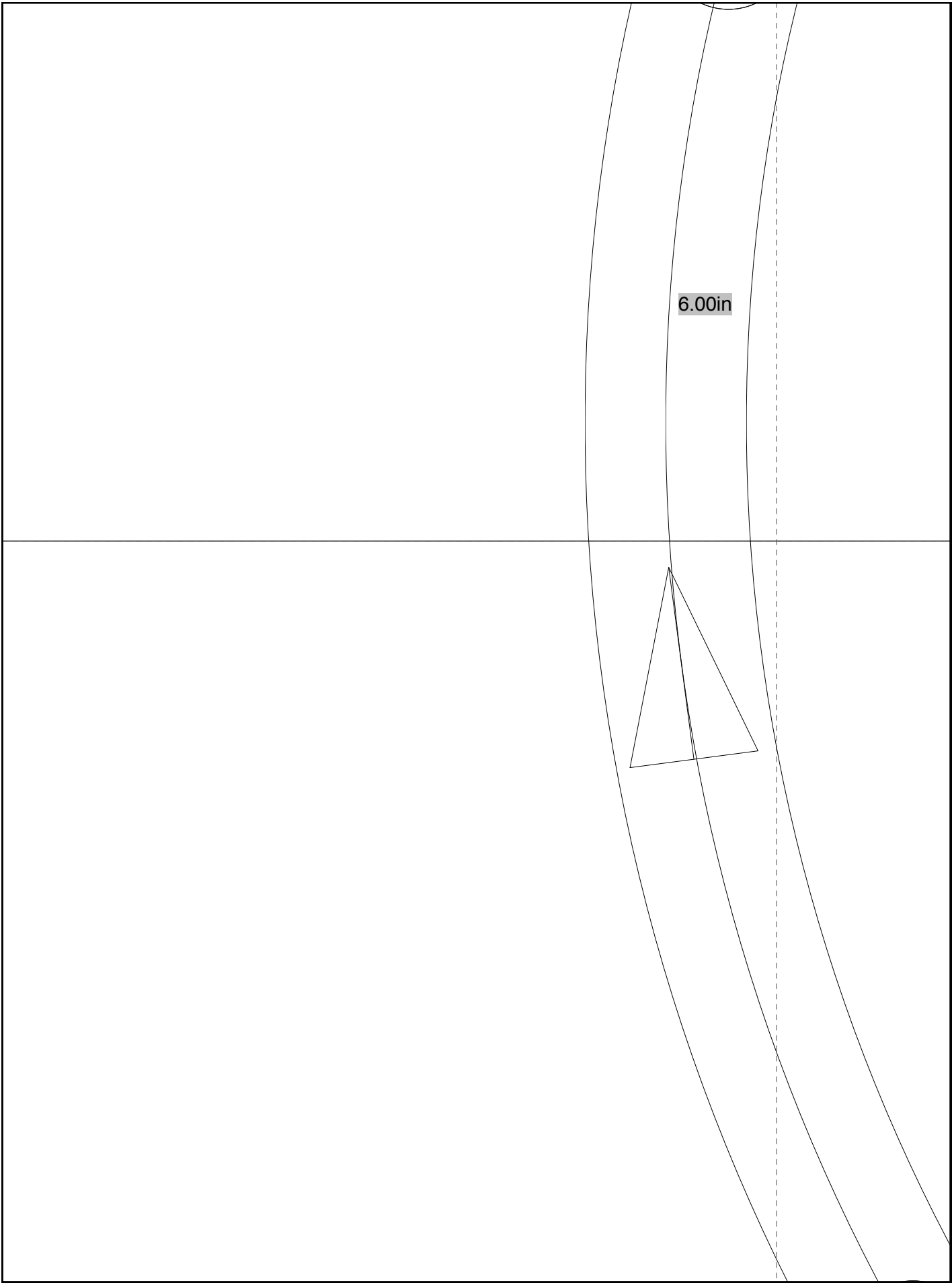

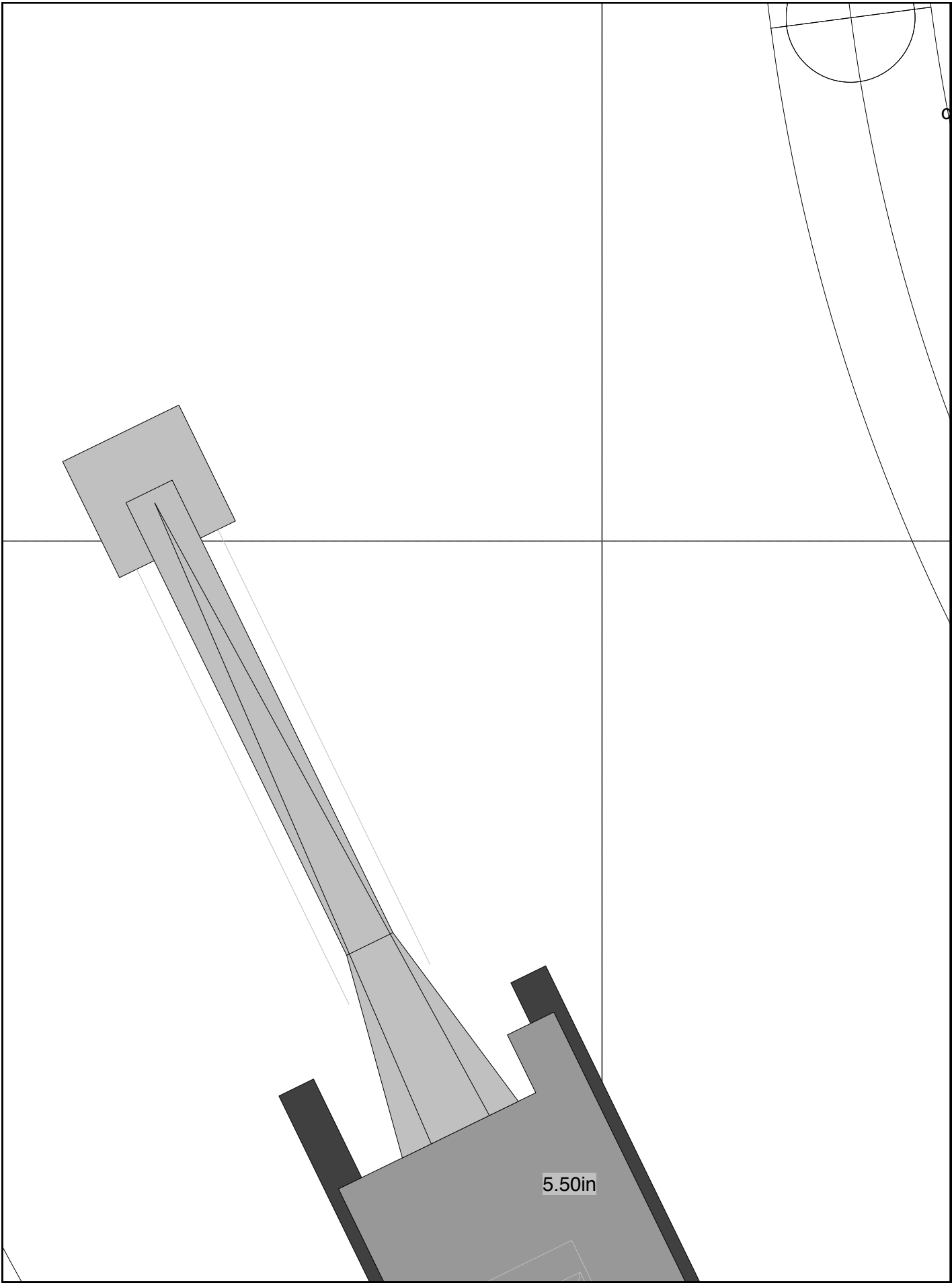

5.50in

31

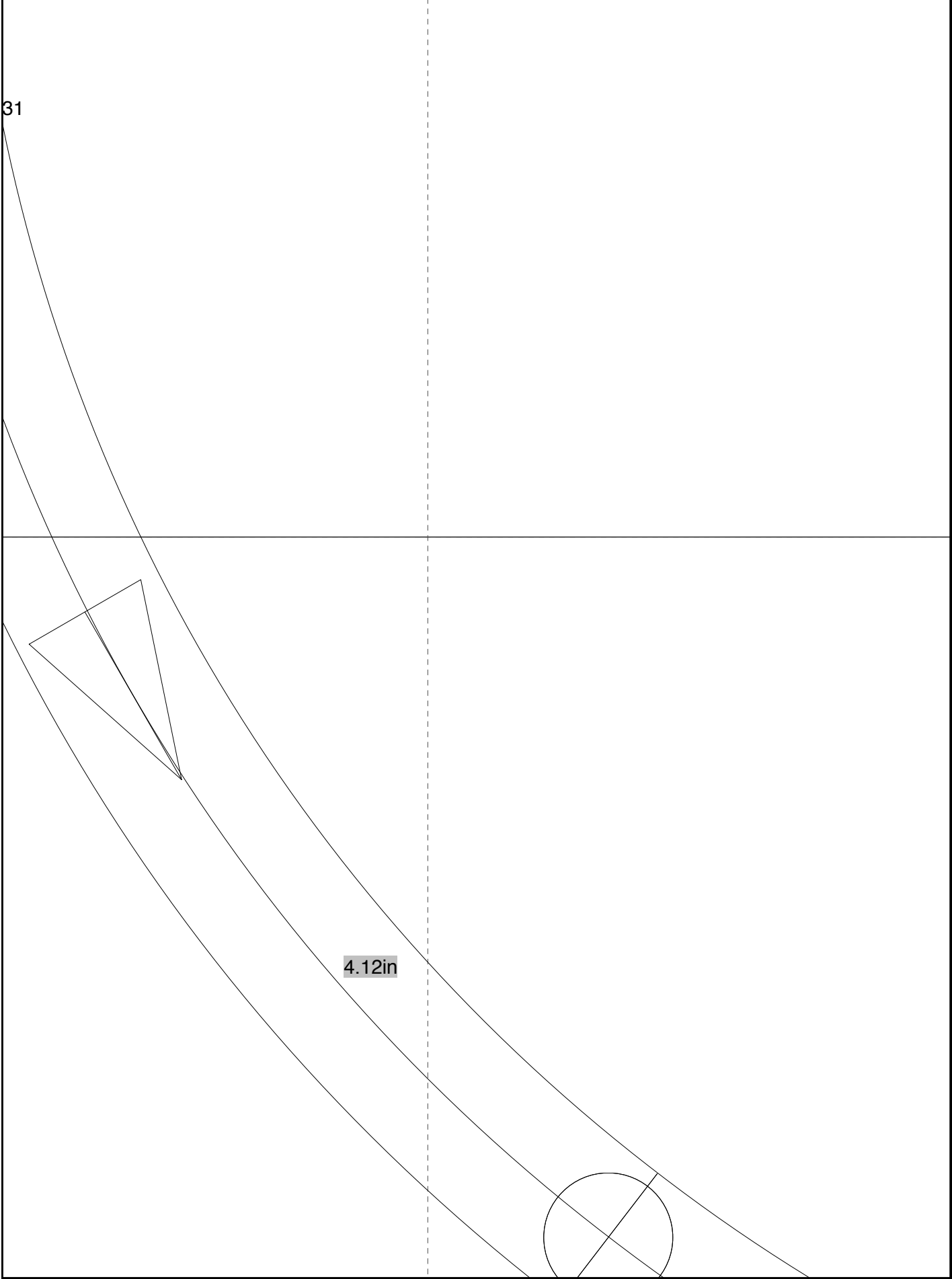

4.12in

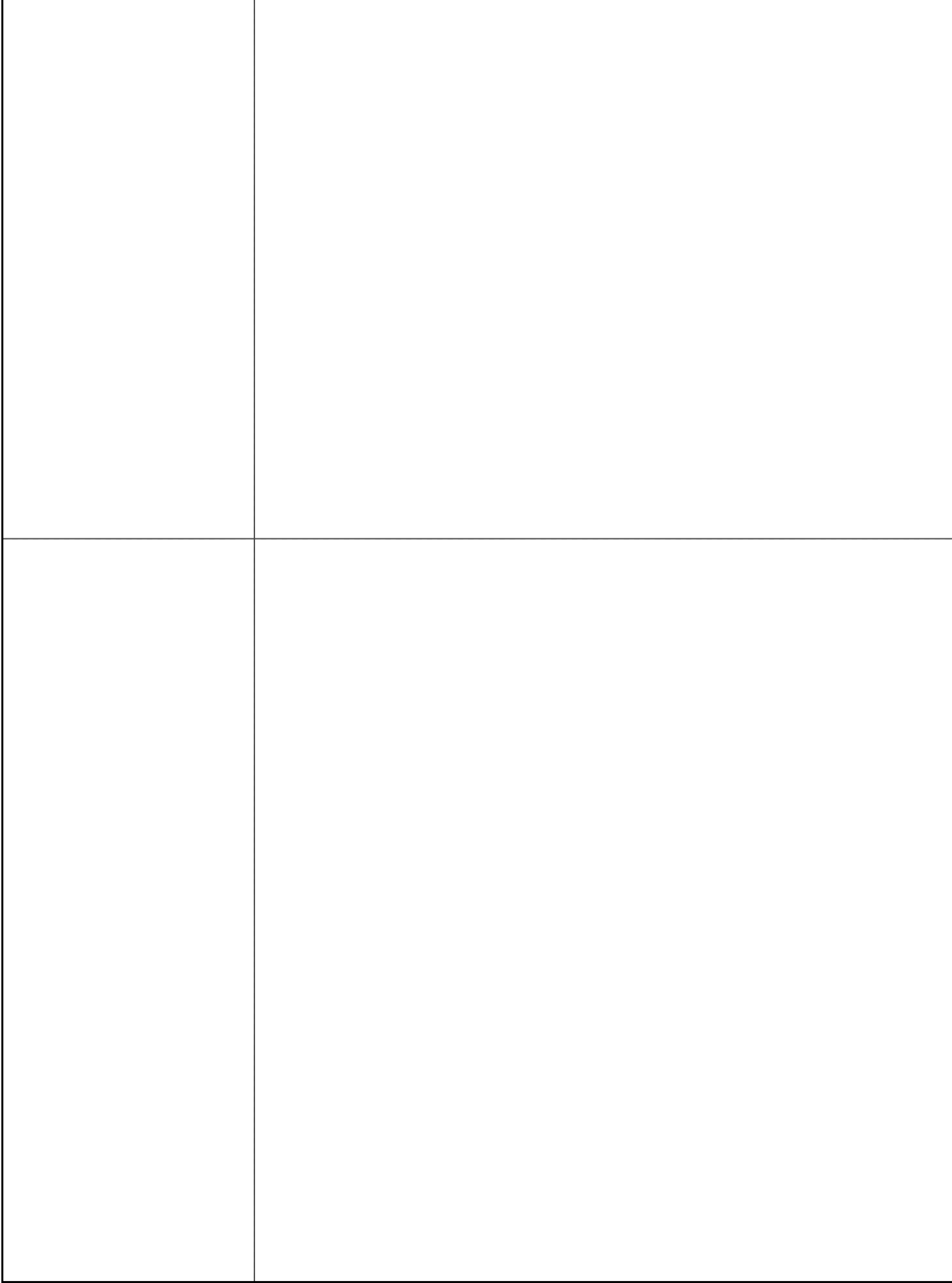

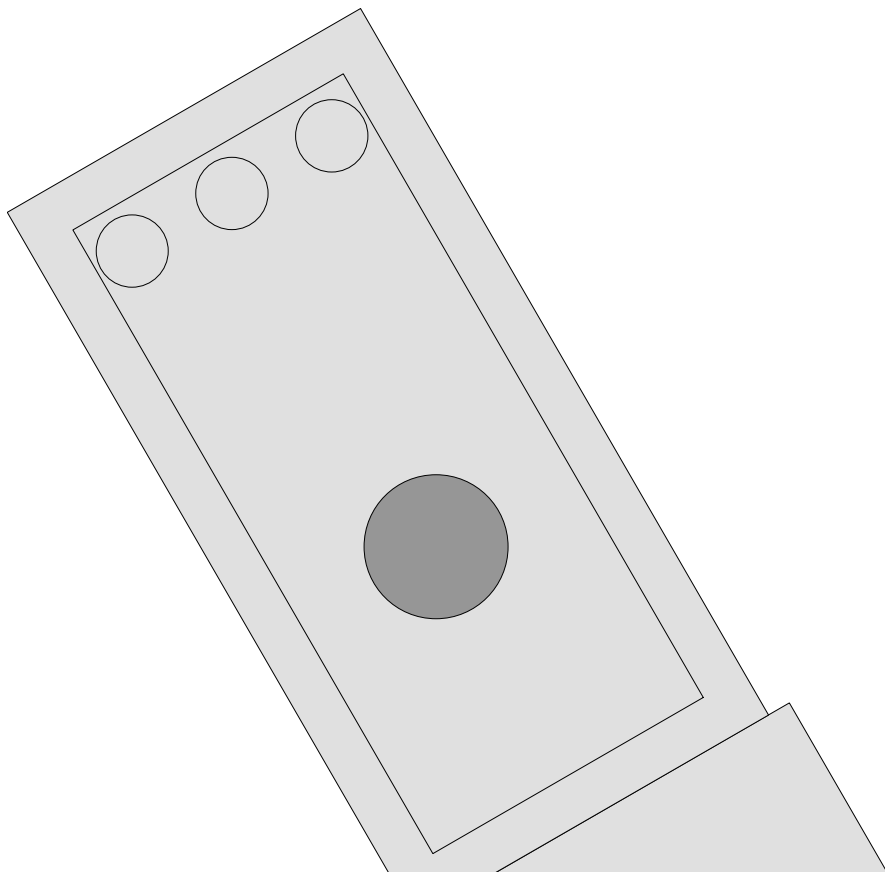

s10

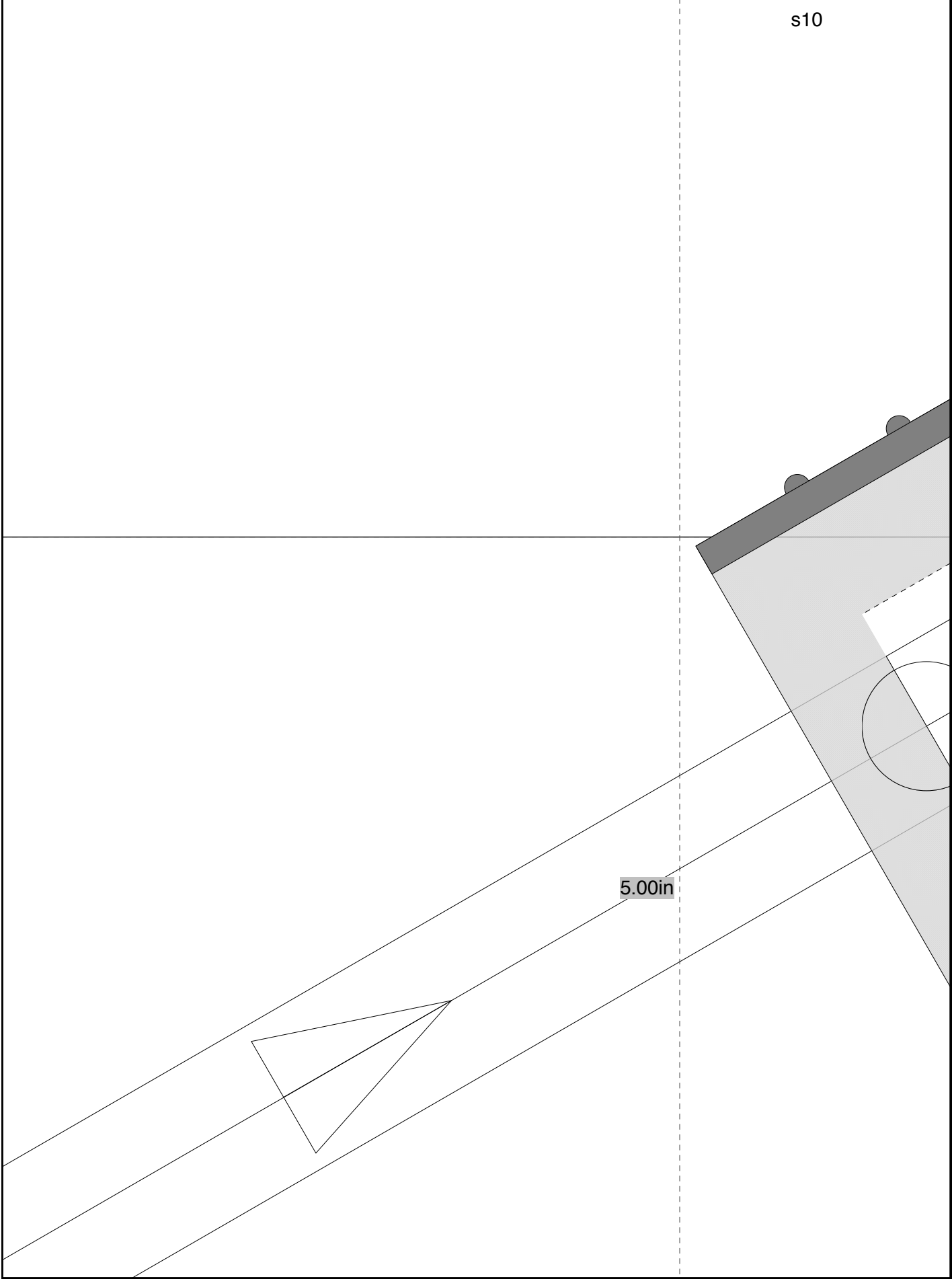

5.00in



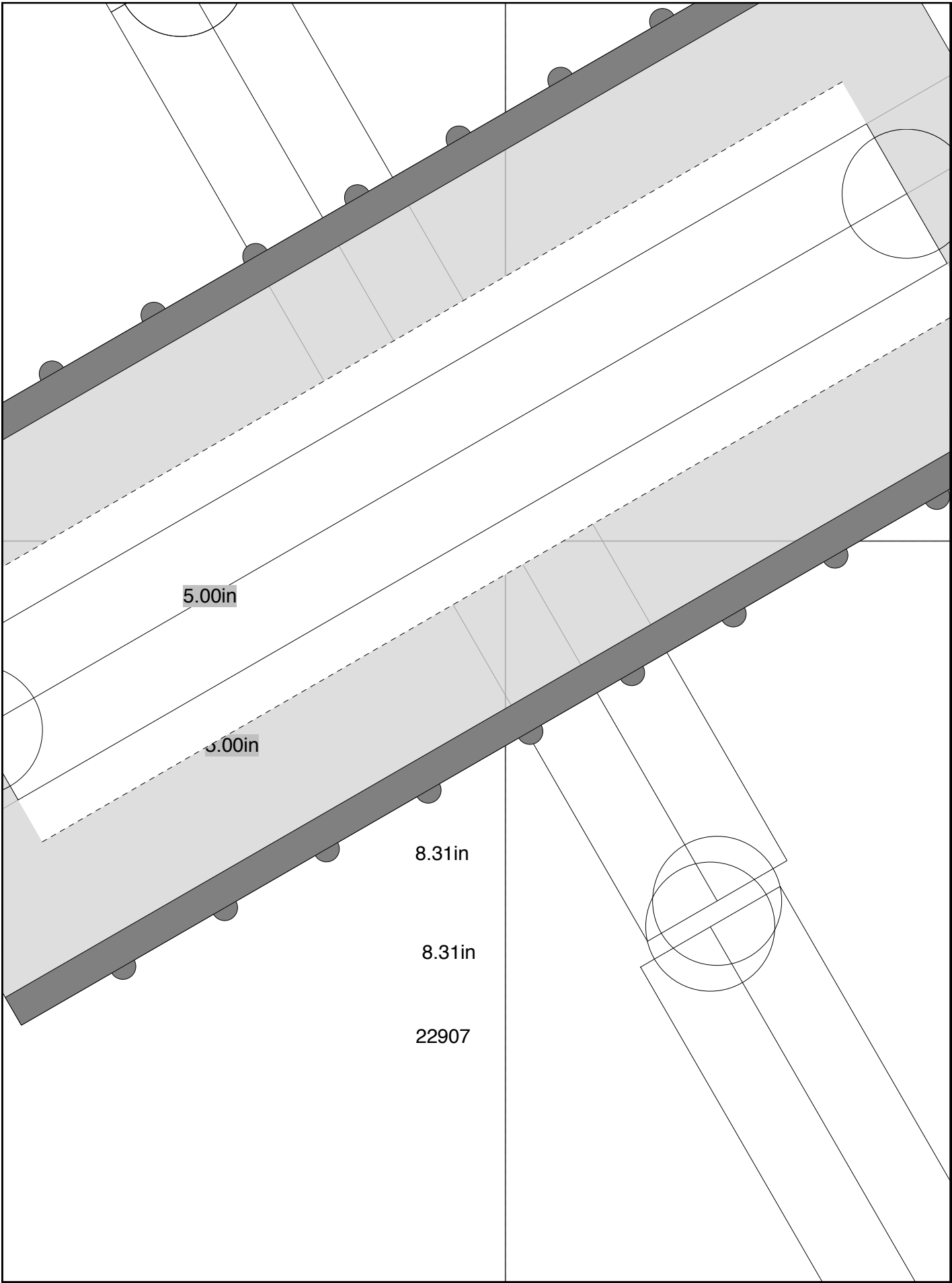

5.00in

5.00in

8.31in

8.31in

22907

5.00in

s10

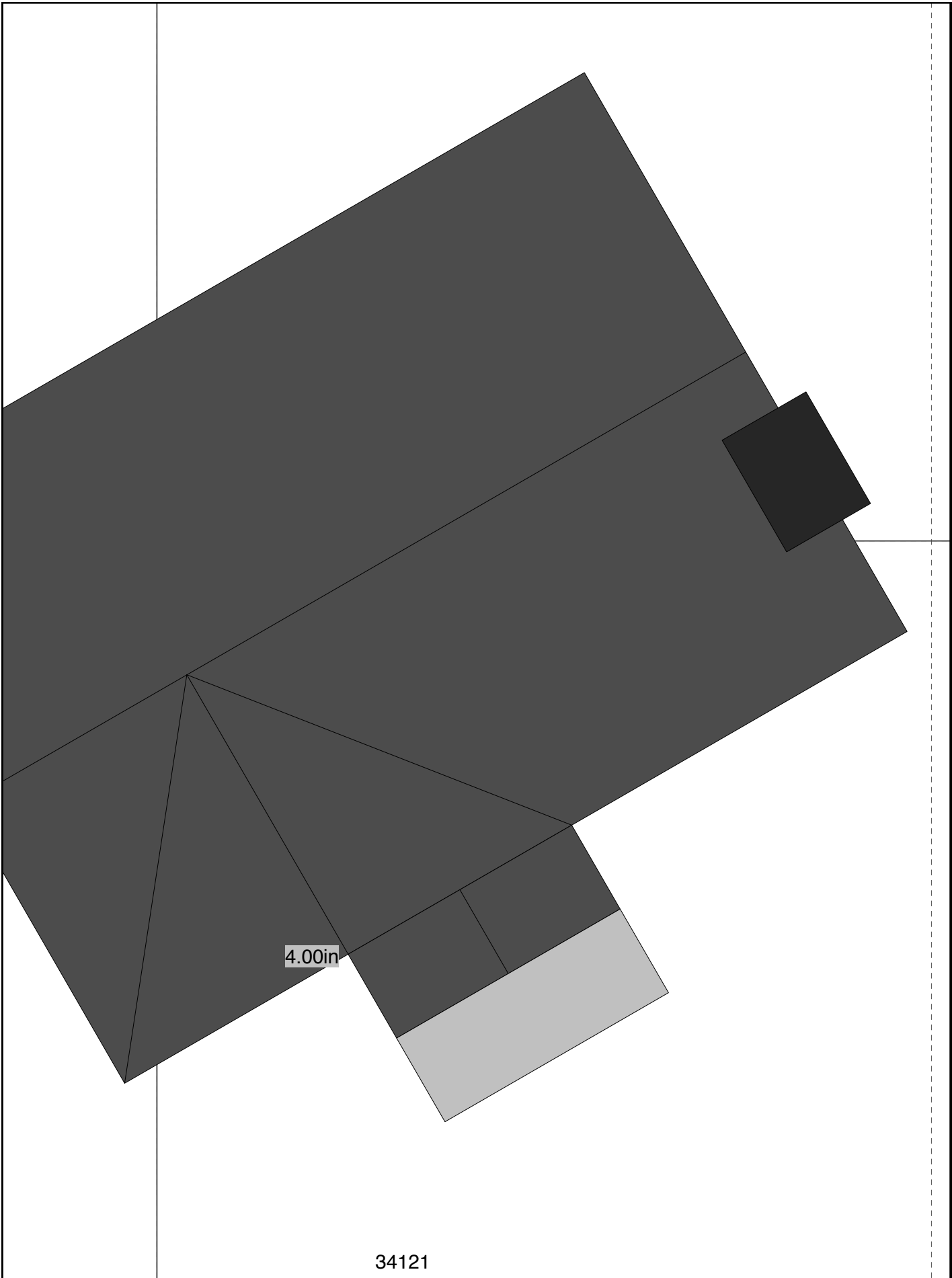

4.00in

34121

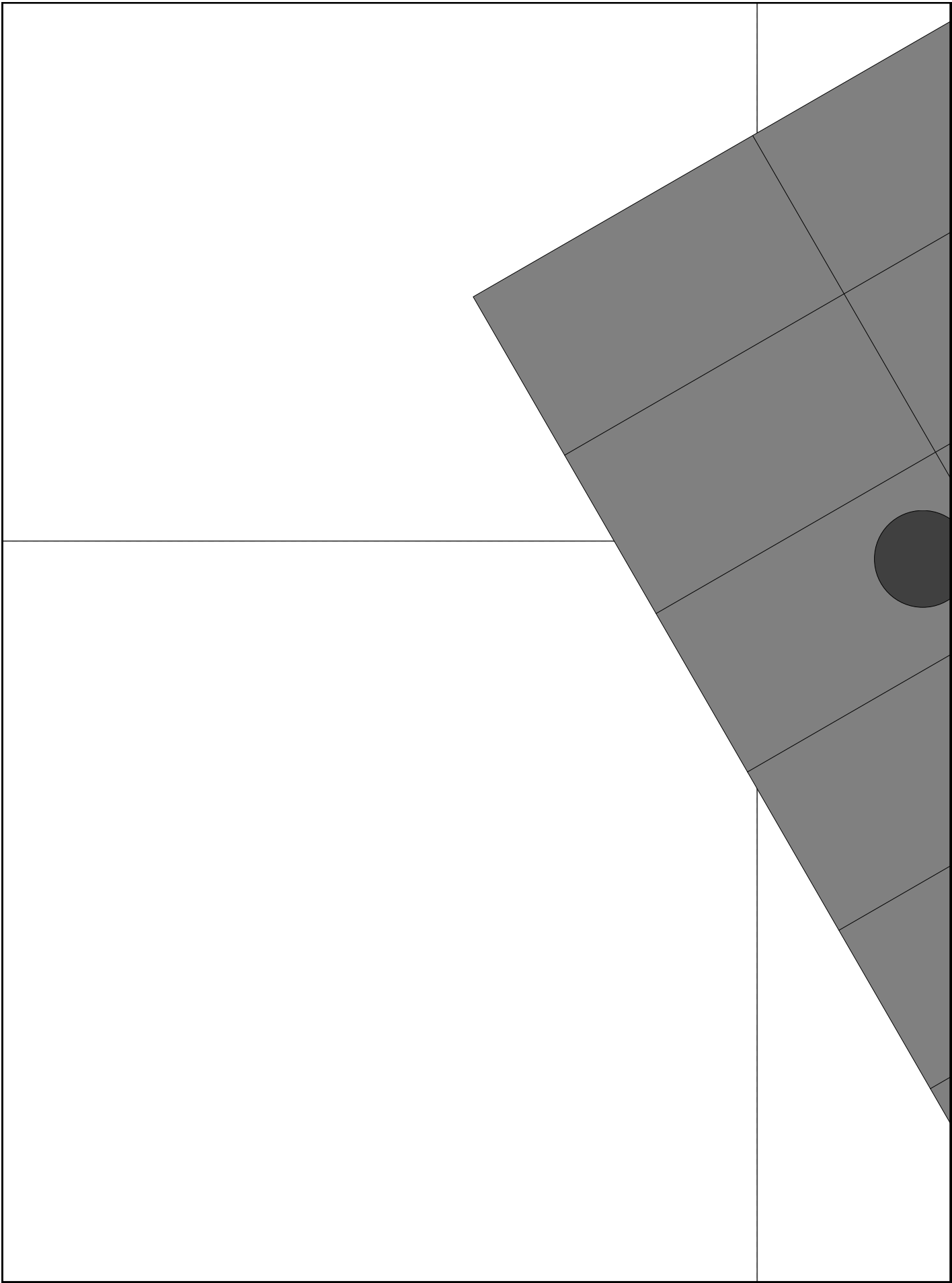

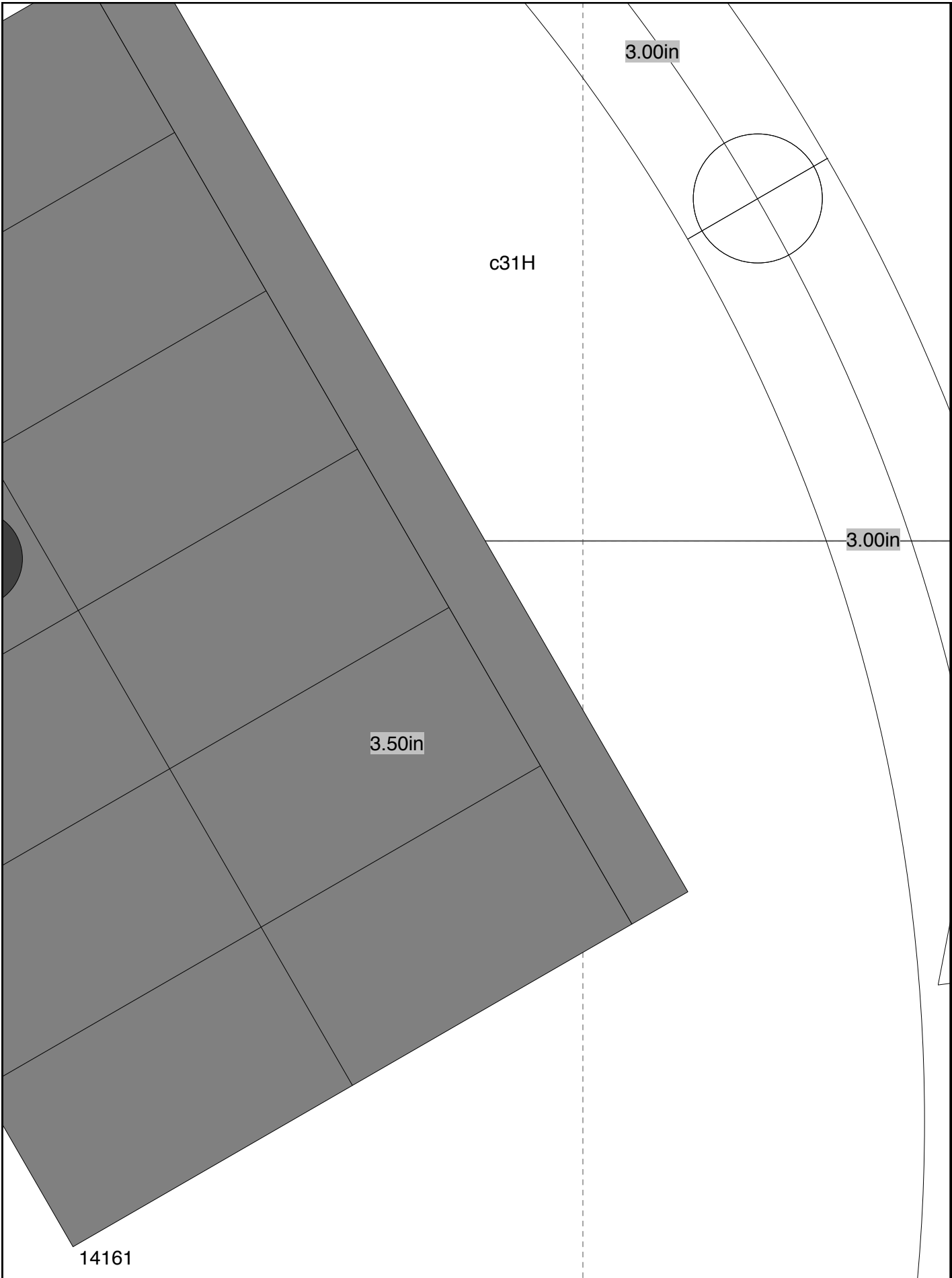

14161

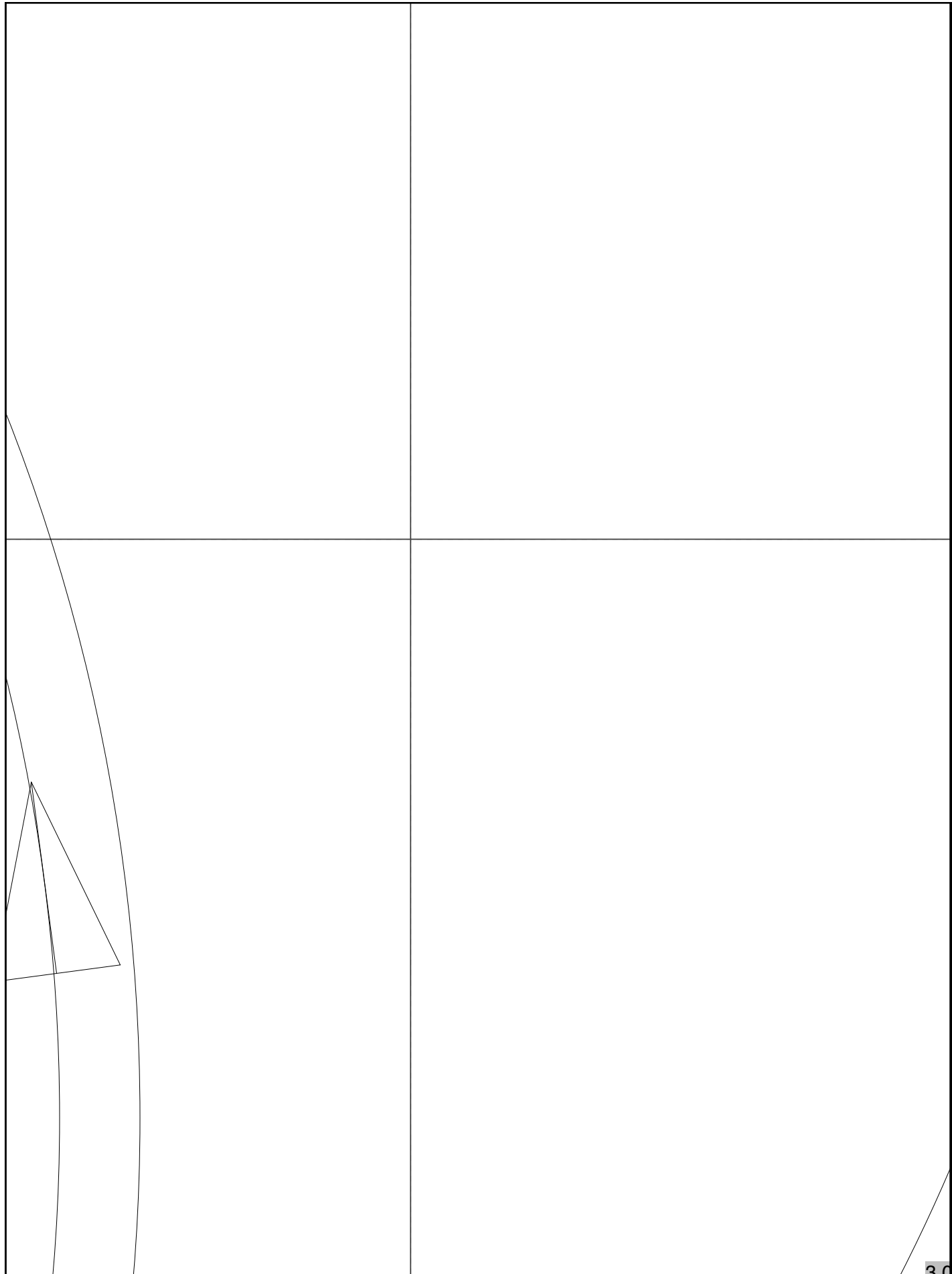

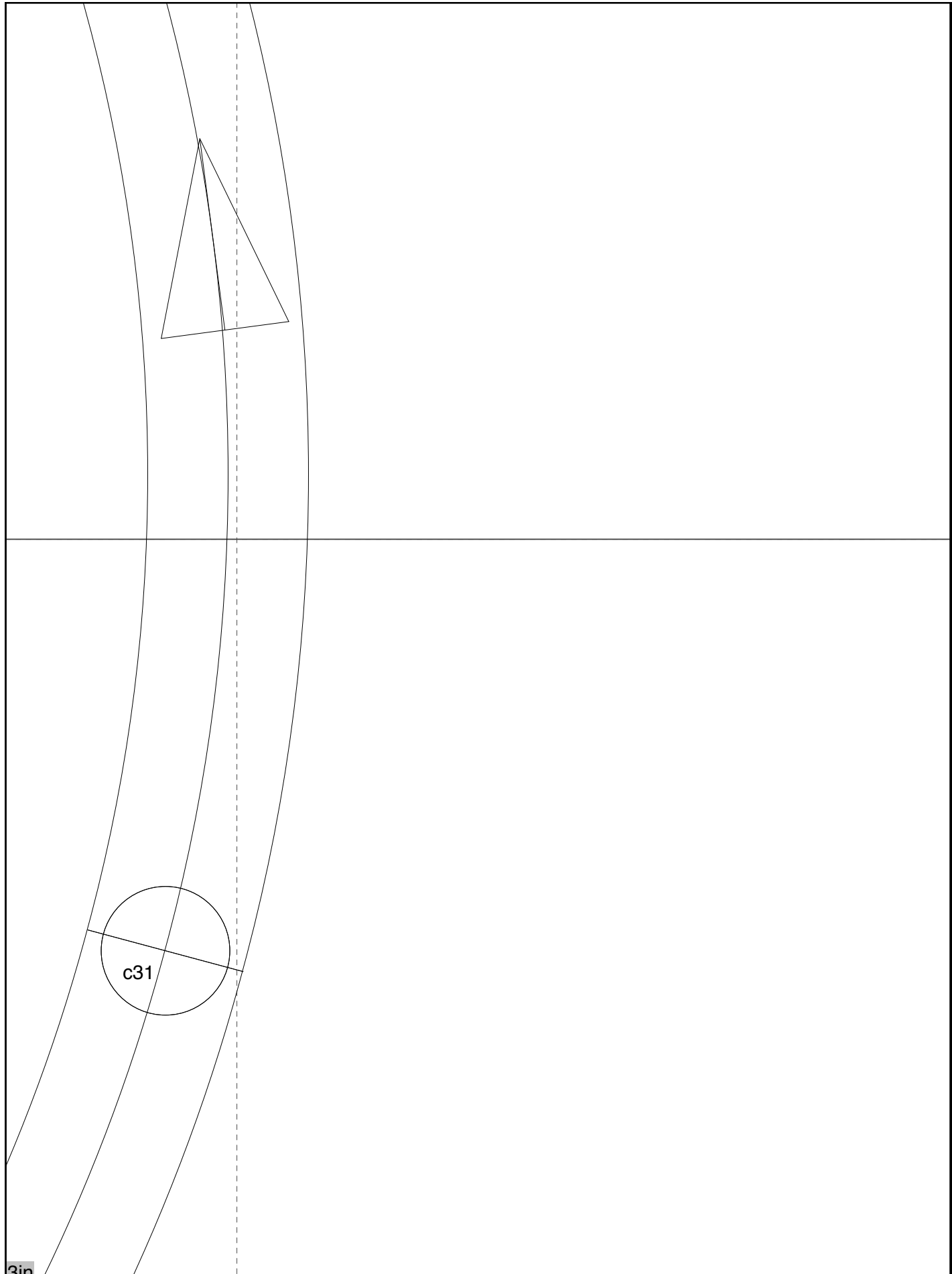

3in

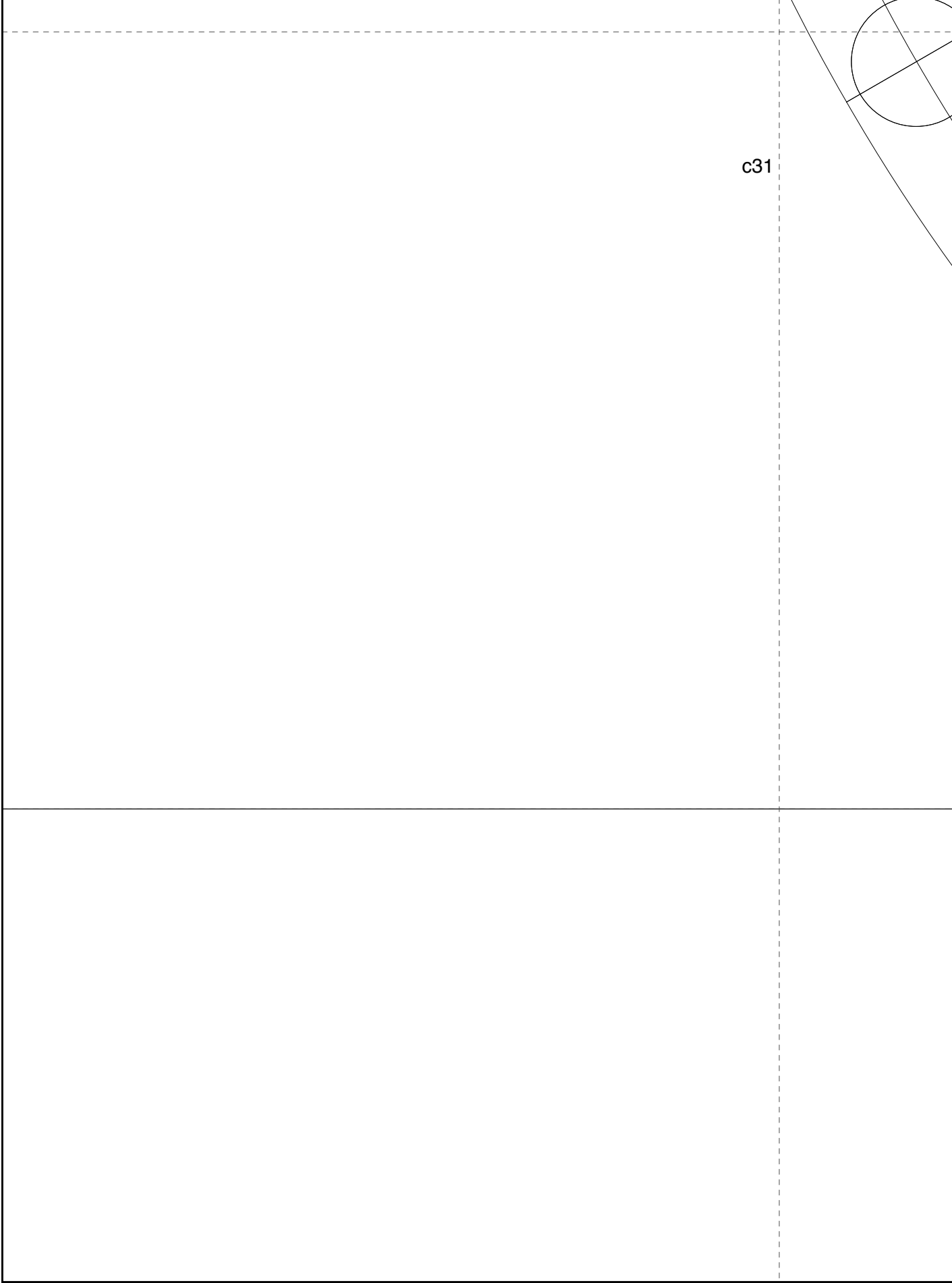

c31





12901

5.50in

c31

c31

c31H

5.00in

c31



4.50in

The diagram shows a technical drawing of a curved track section. It features a vertical centerline on the left and a horizontal centerline at the bottom. Two curved lines represent the track's profile, with a dimension line indicating a width of 4.50 inches. Two circles are drawn, each with a diagonal cross through its center, positioned on the track curves.

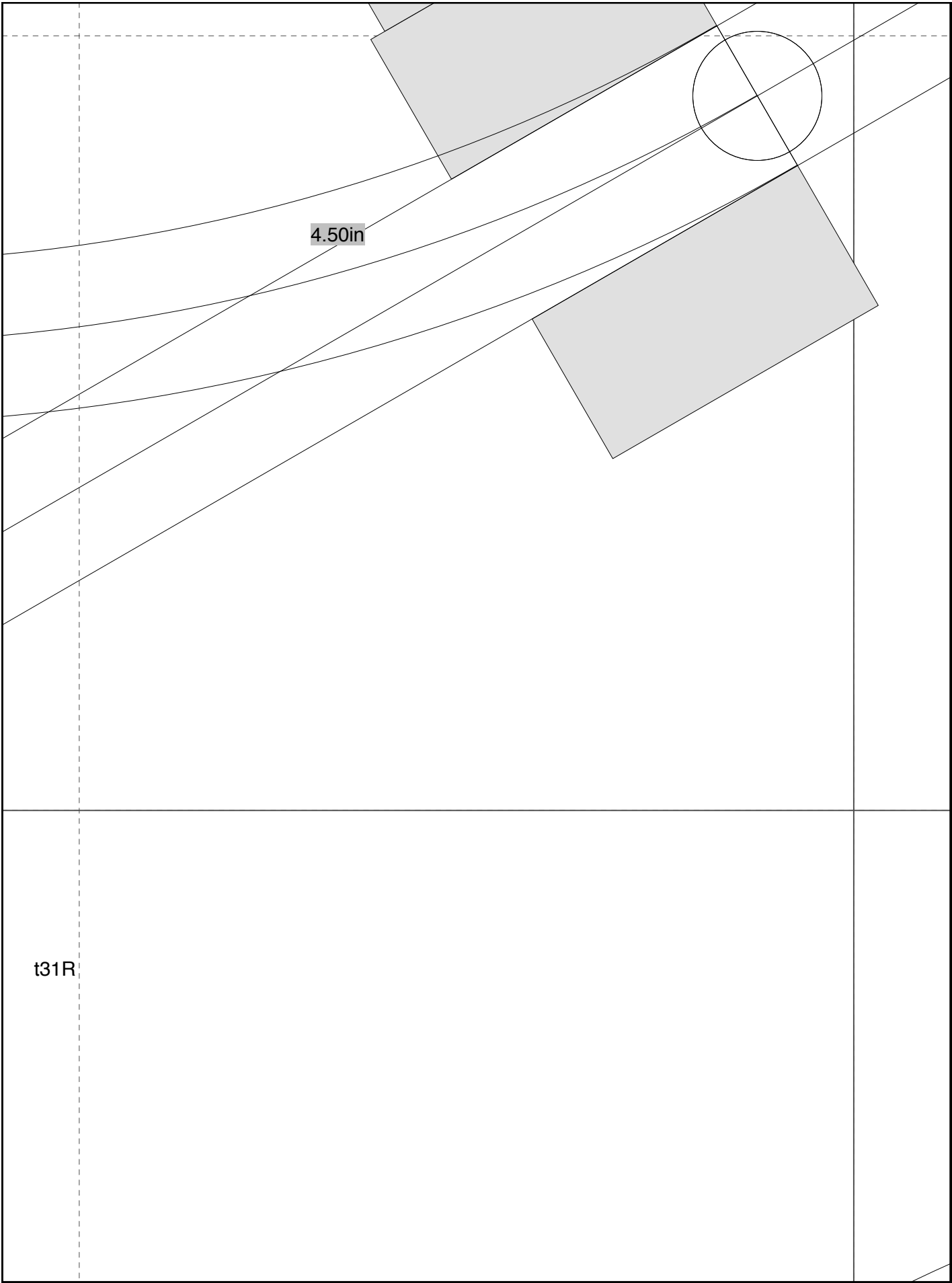

4.50in

t31R

s10

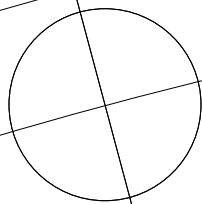

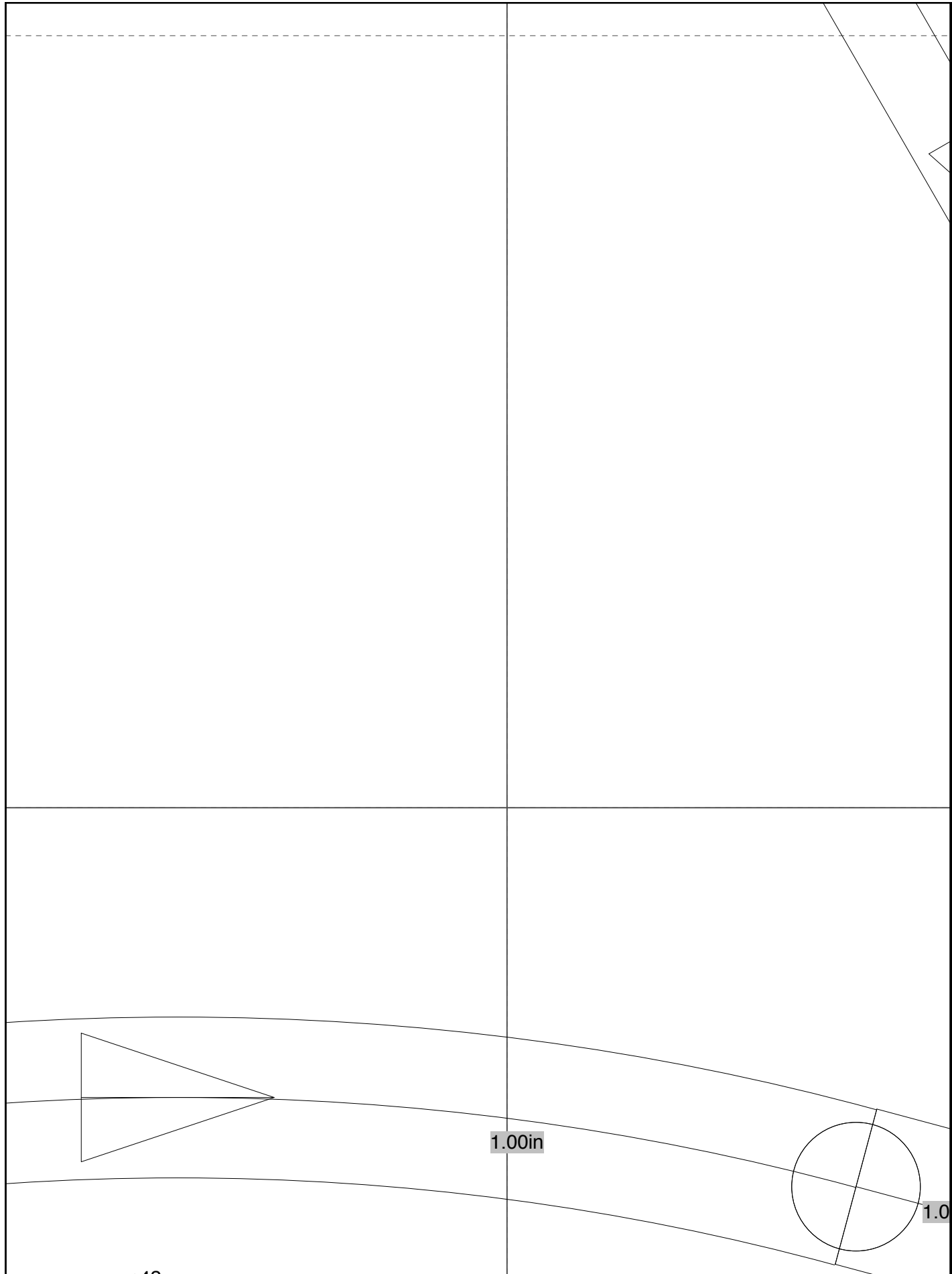

1.00in

1.0

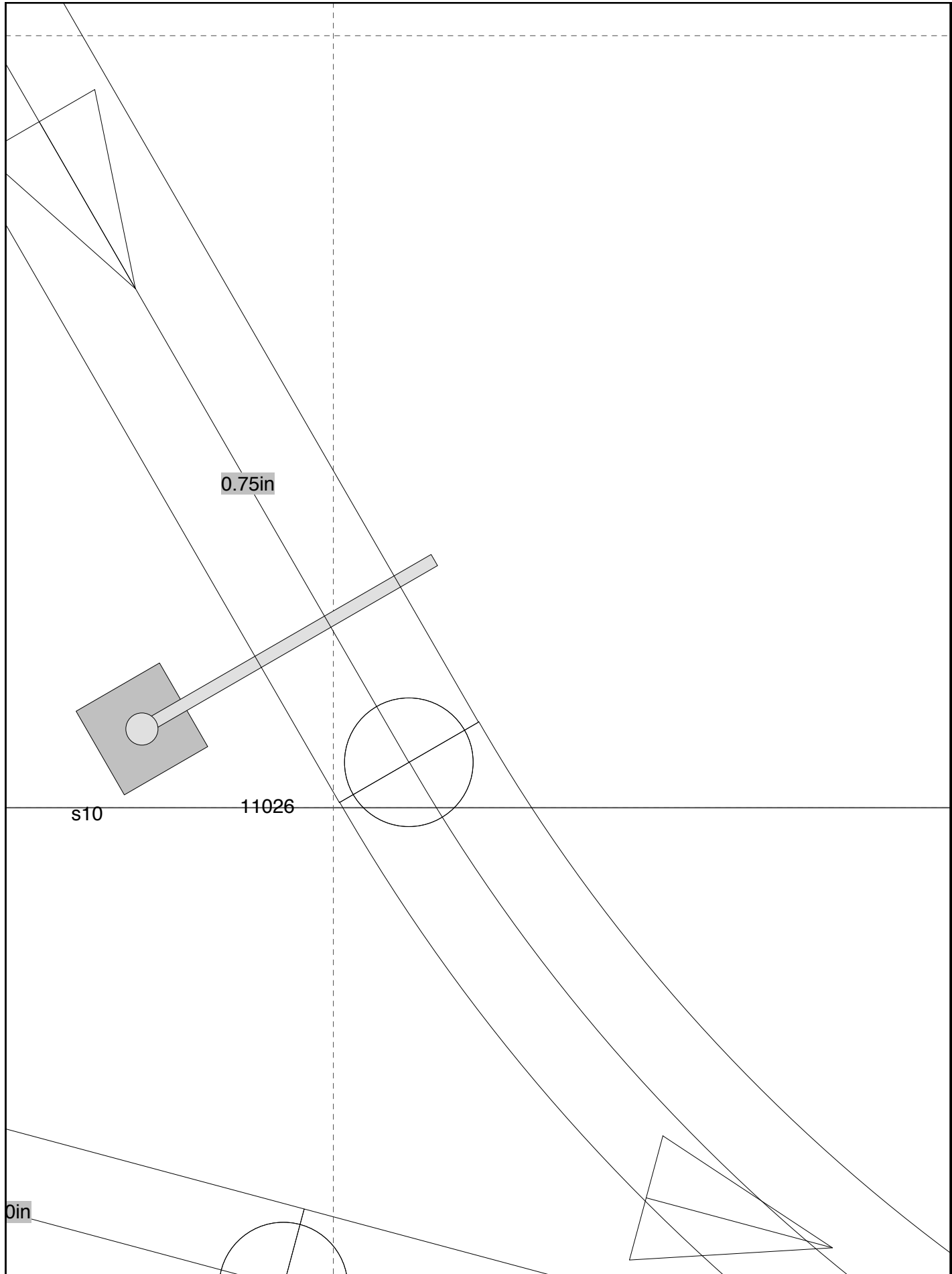

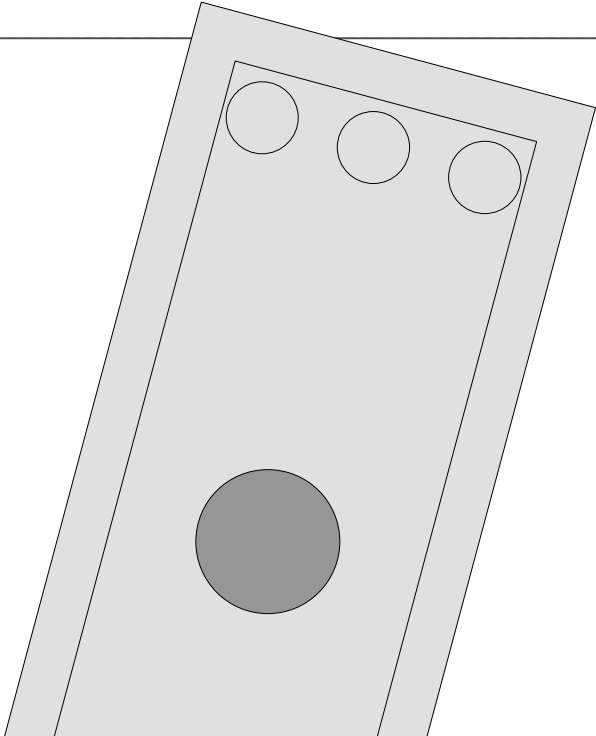
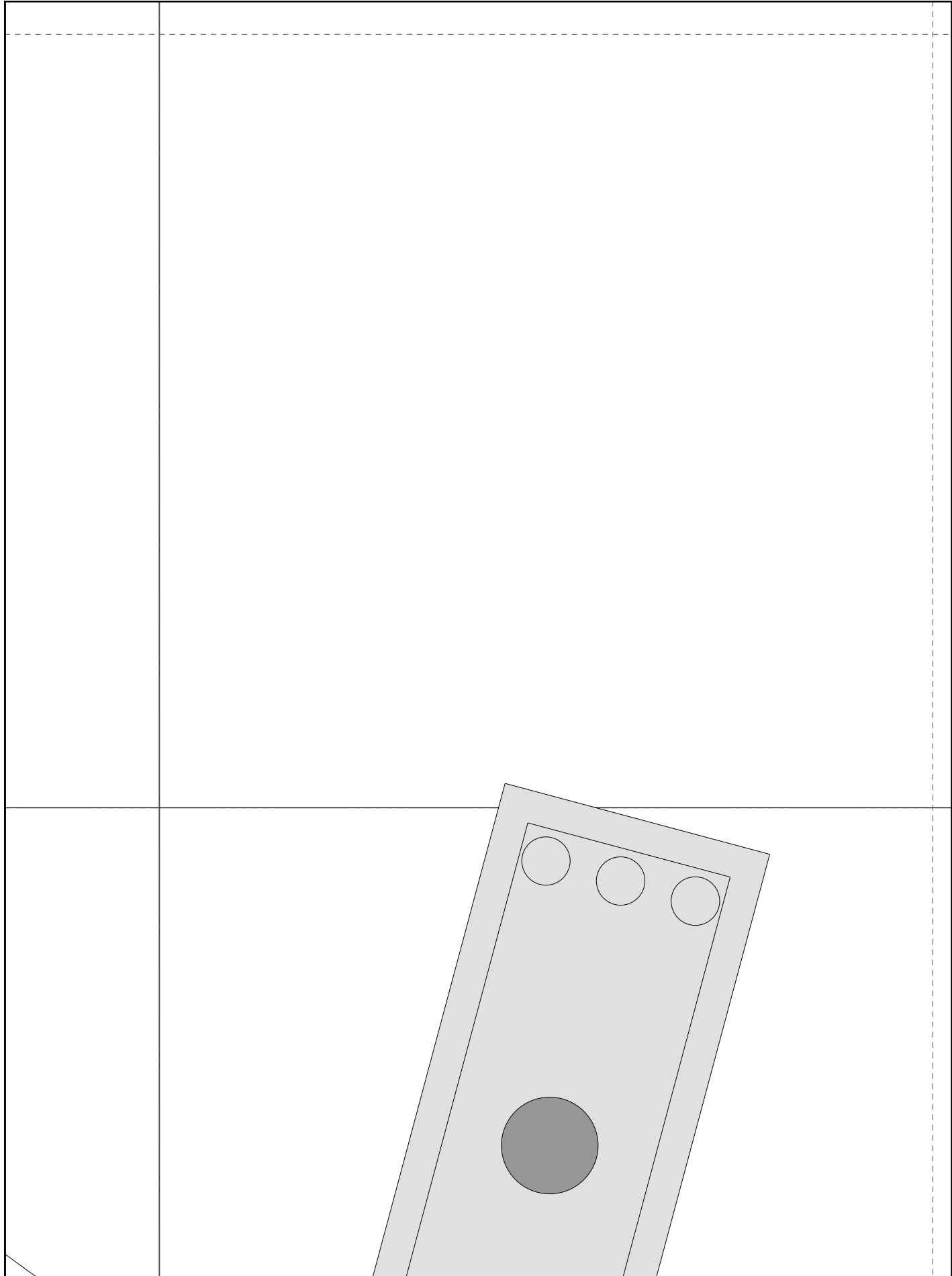



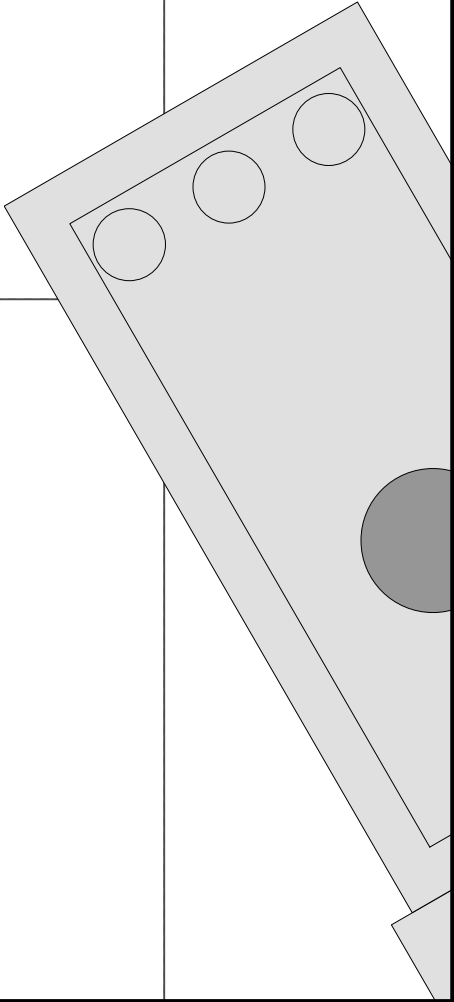
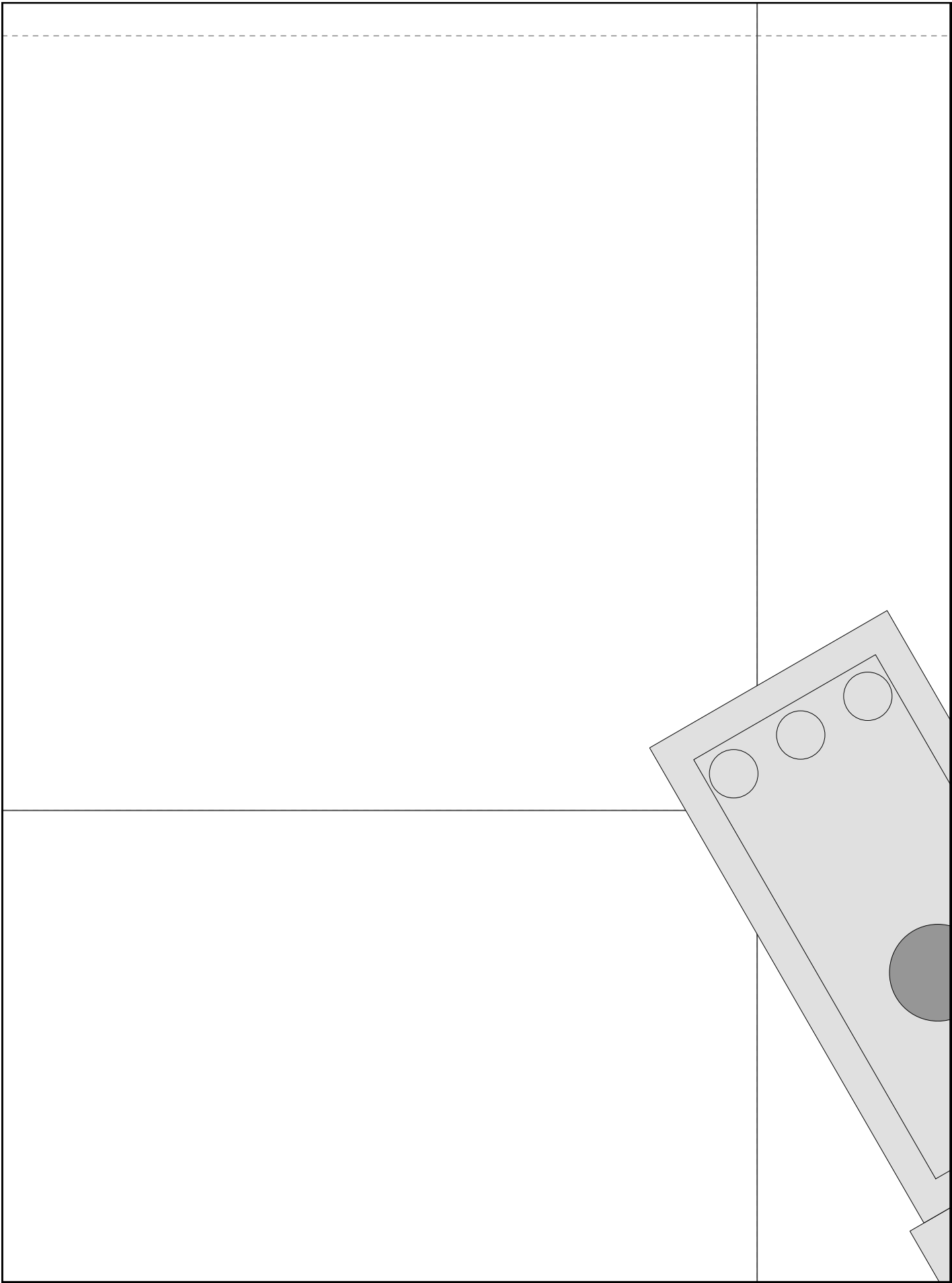



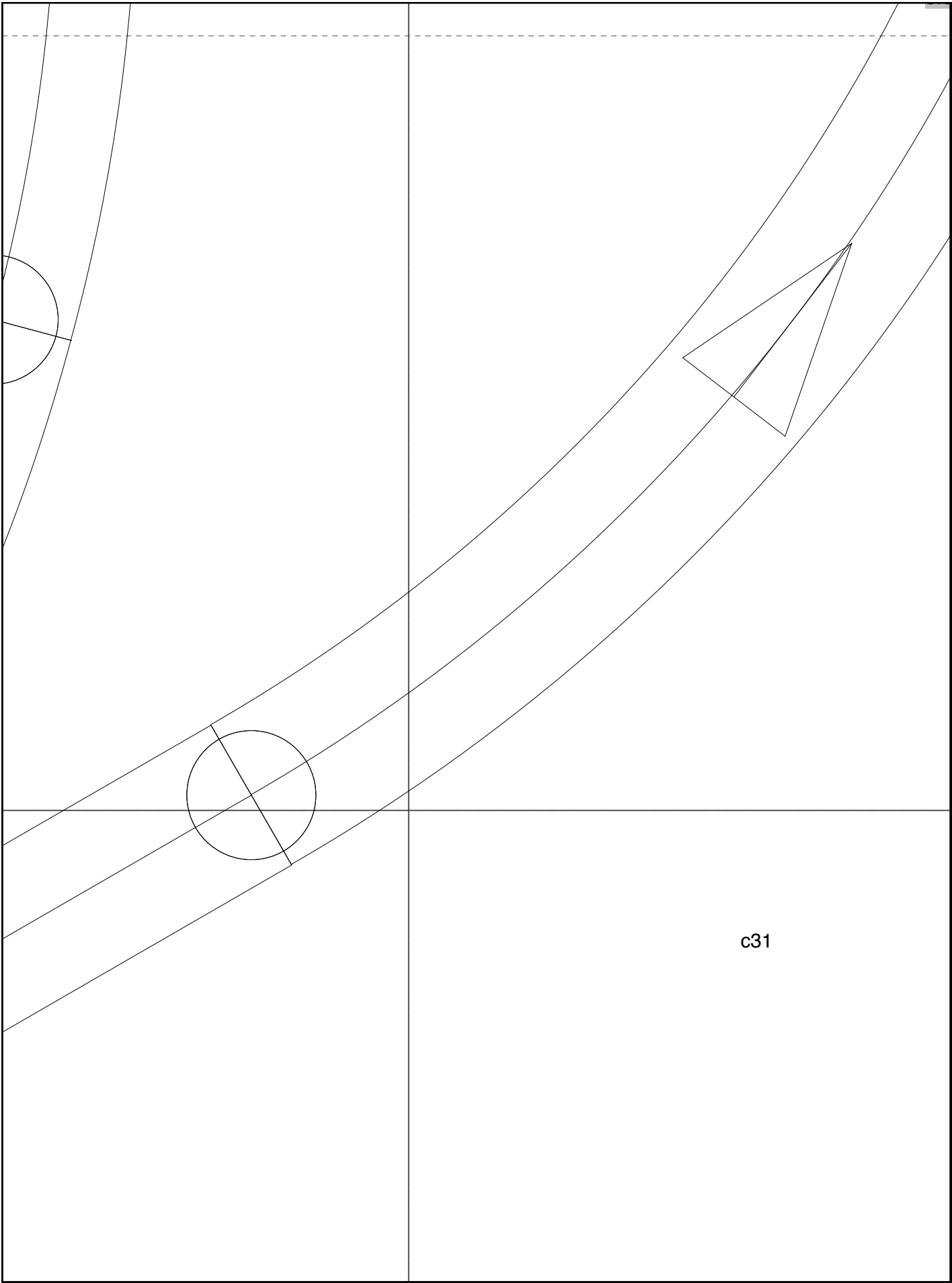

c31

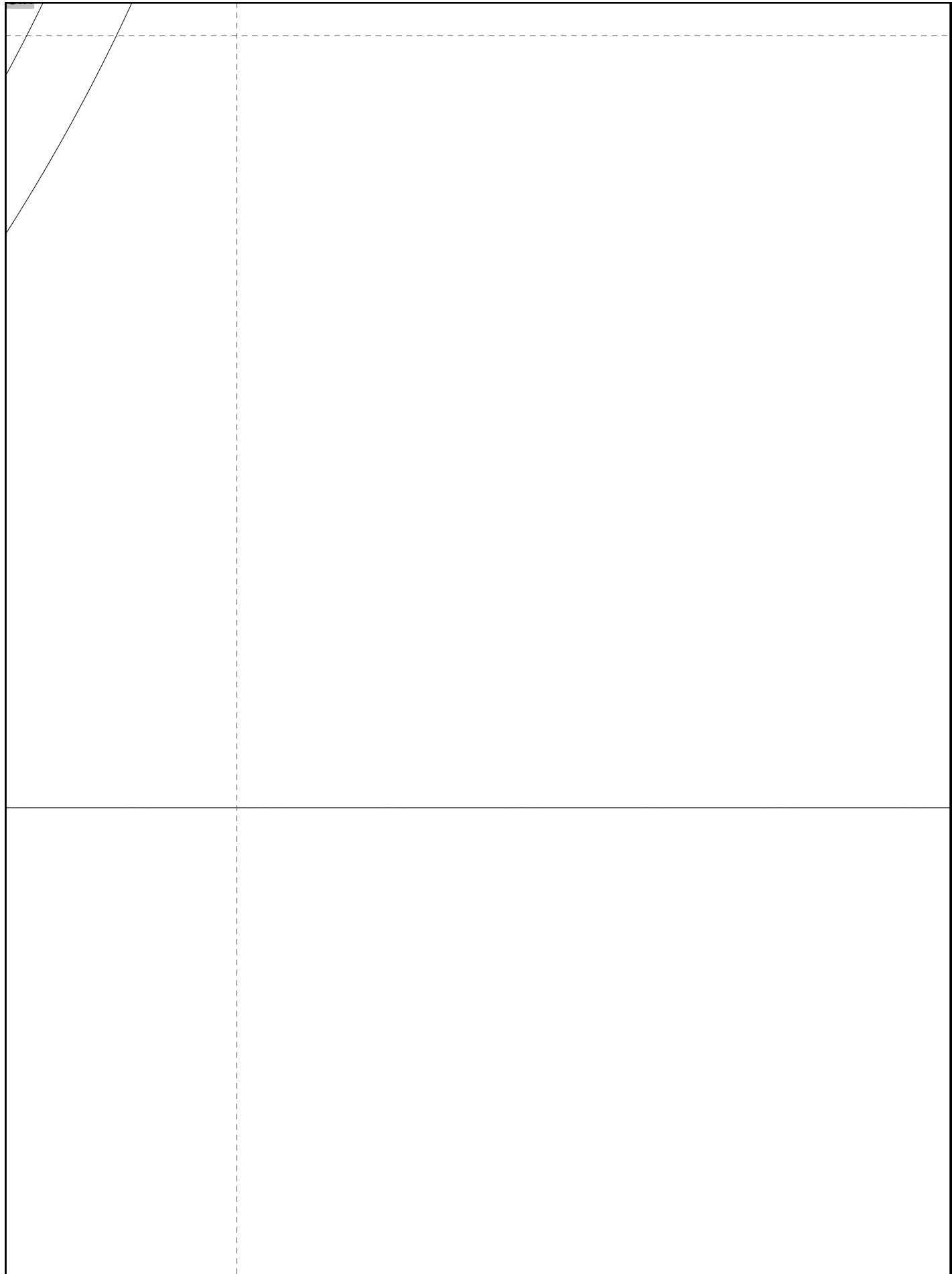

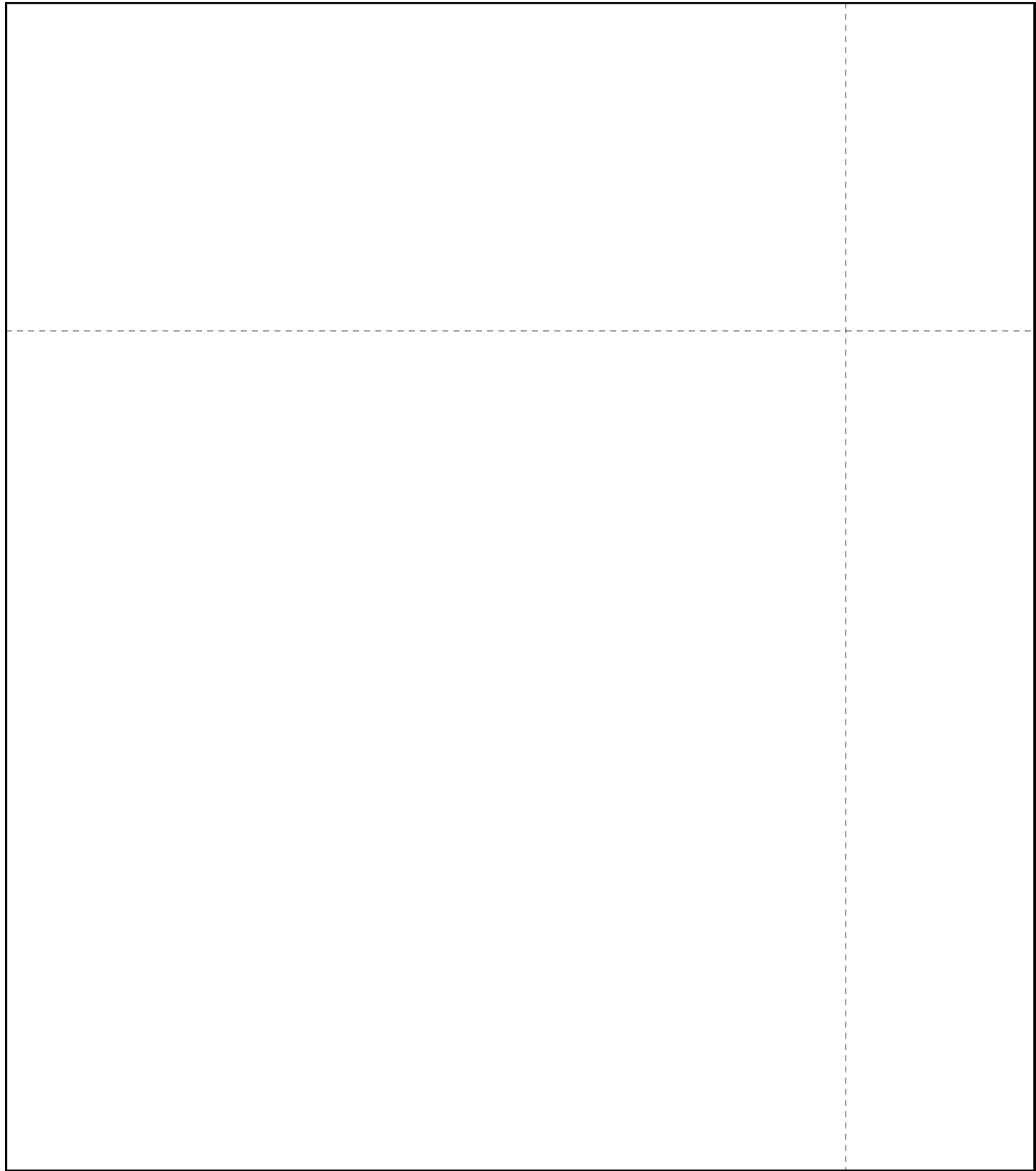

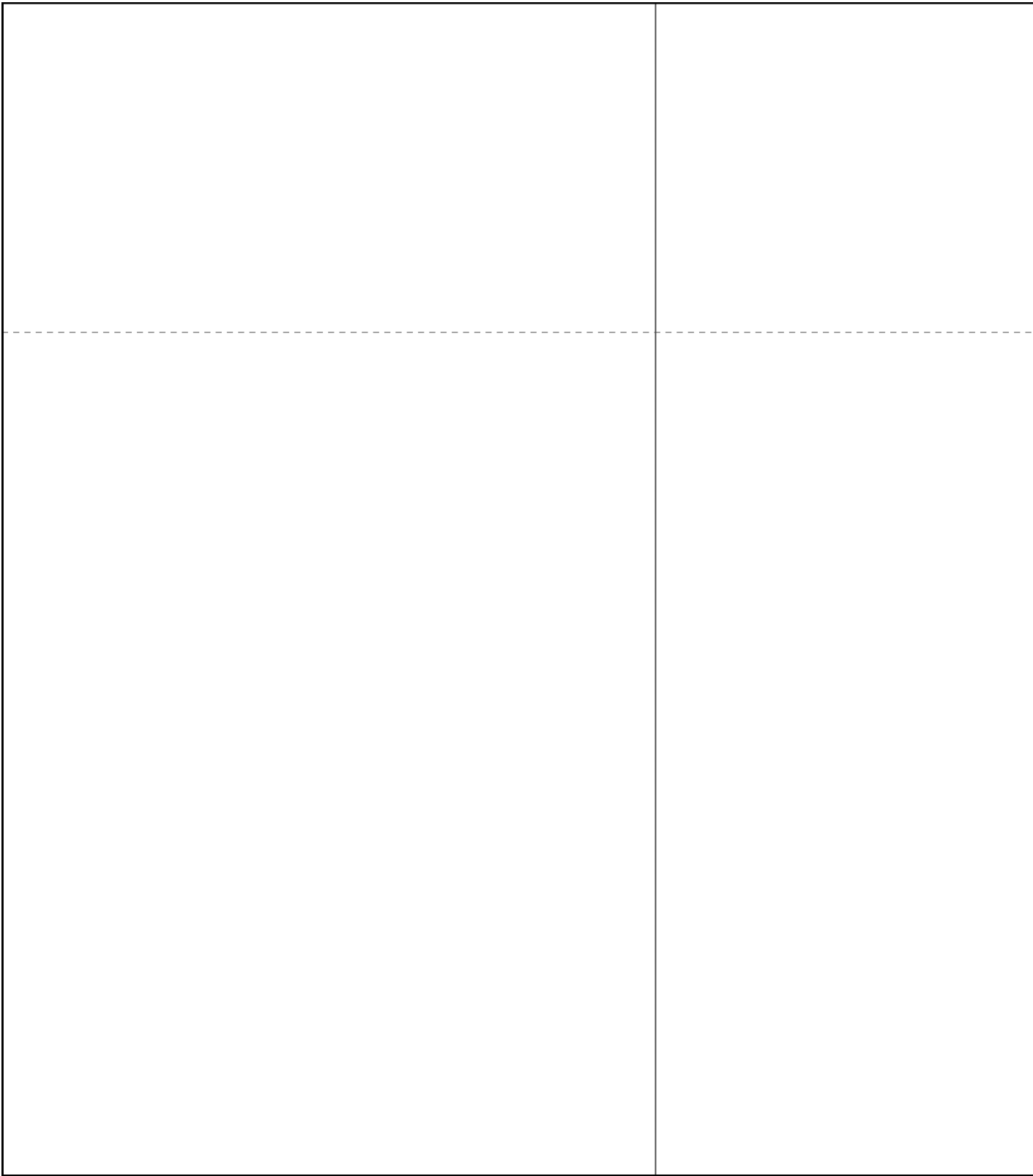

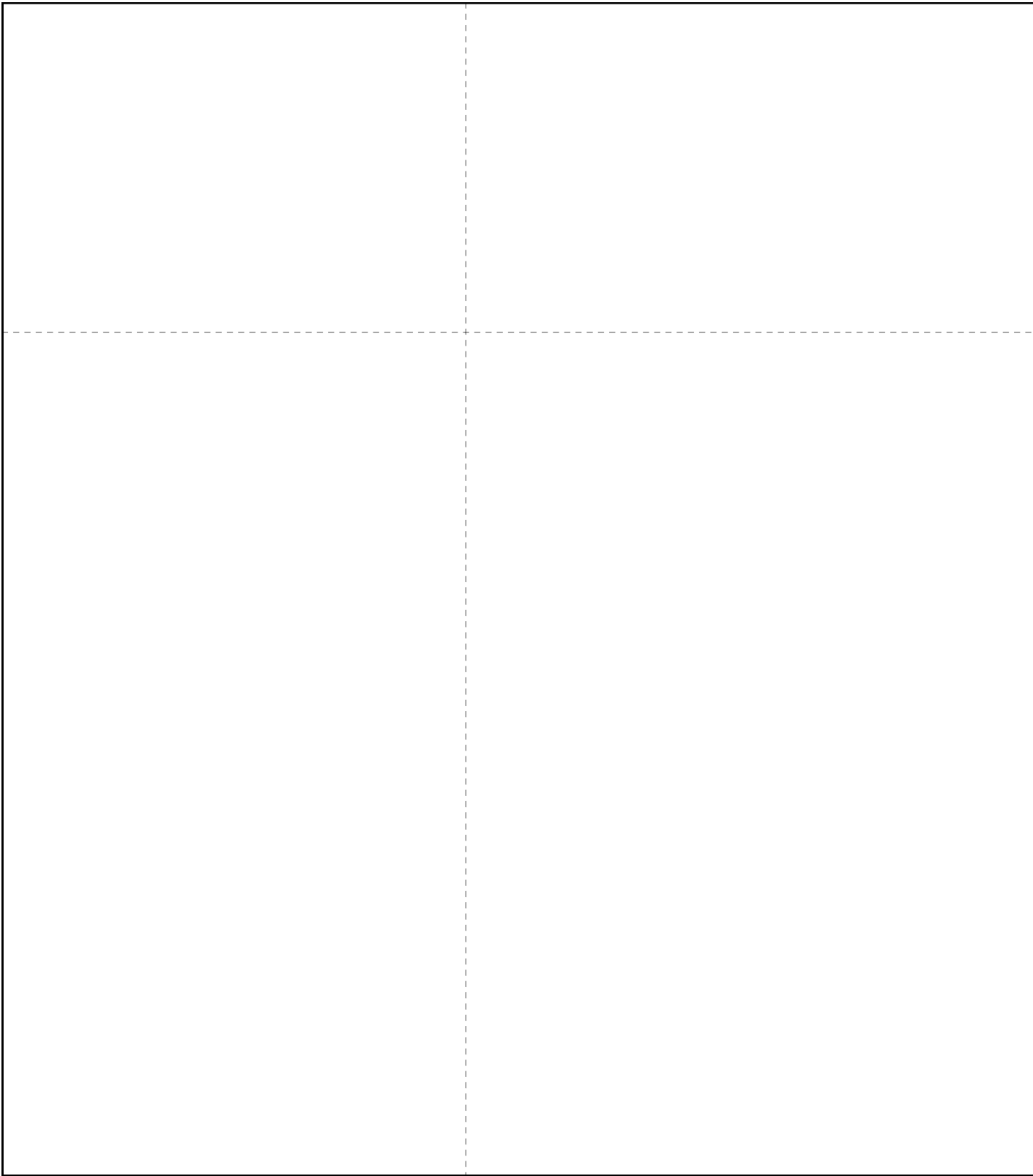

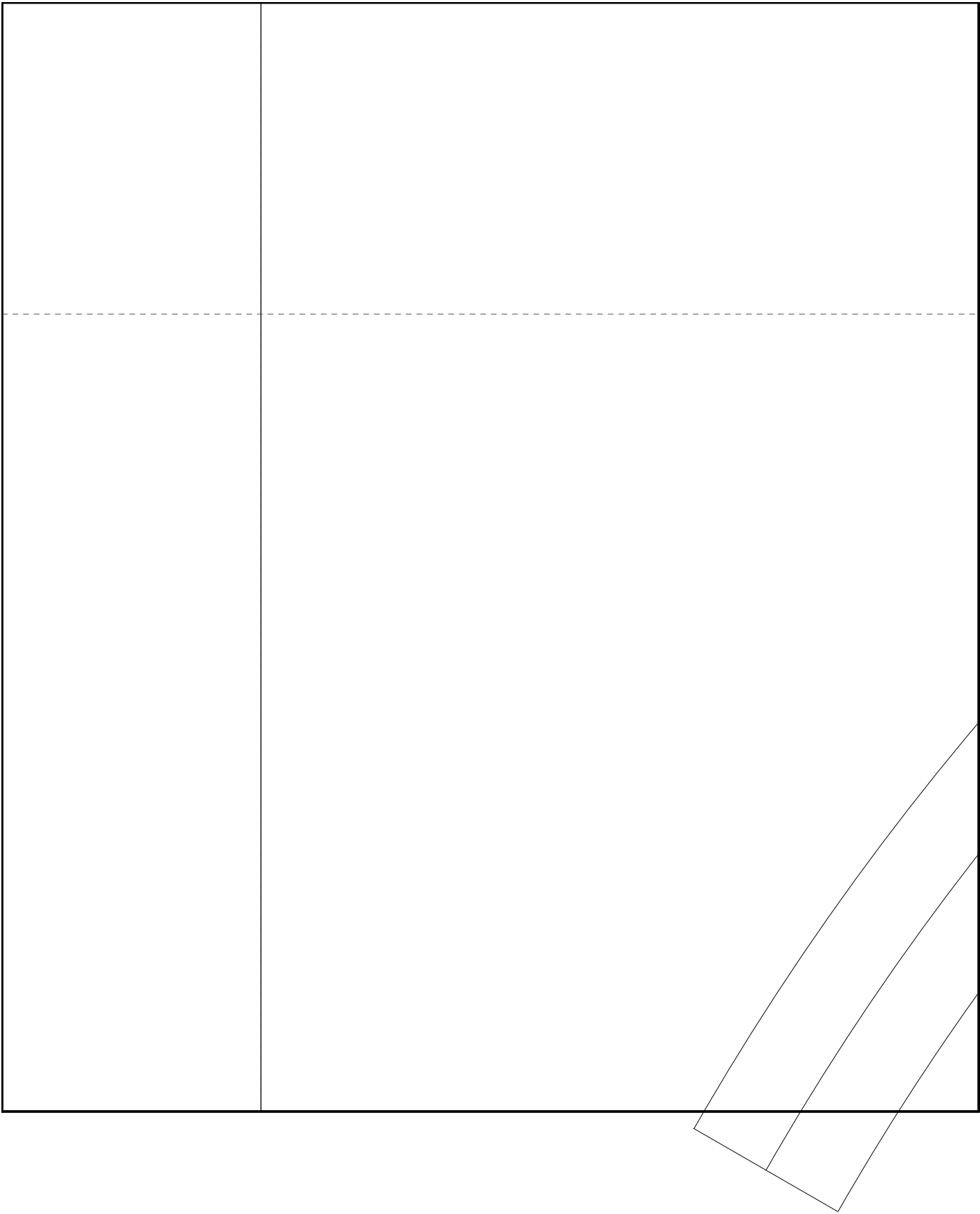

c42x



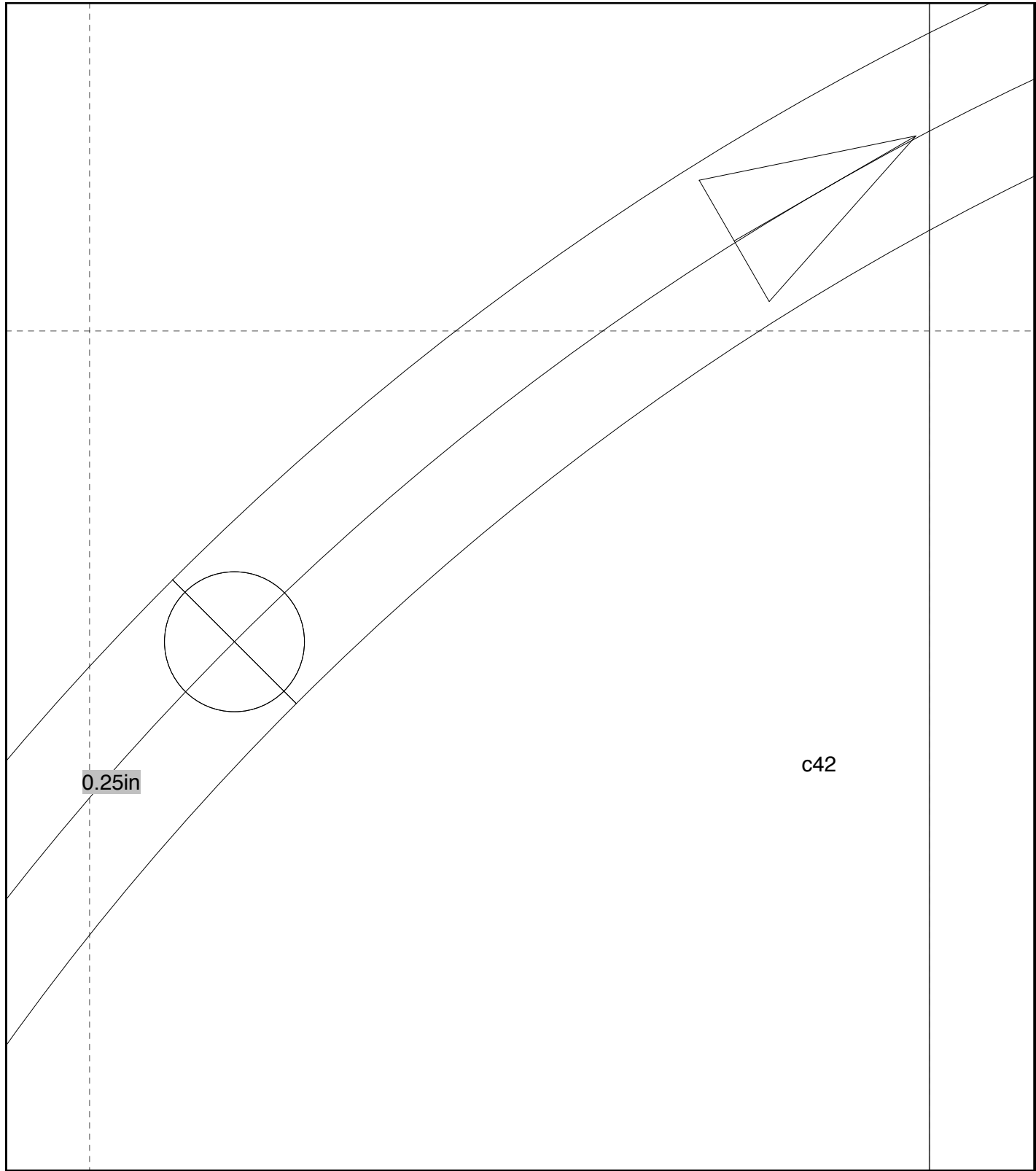

0.25in

c42

0.63in

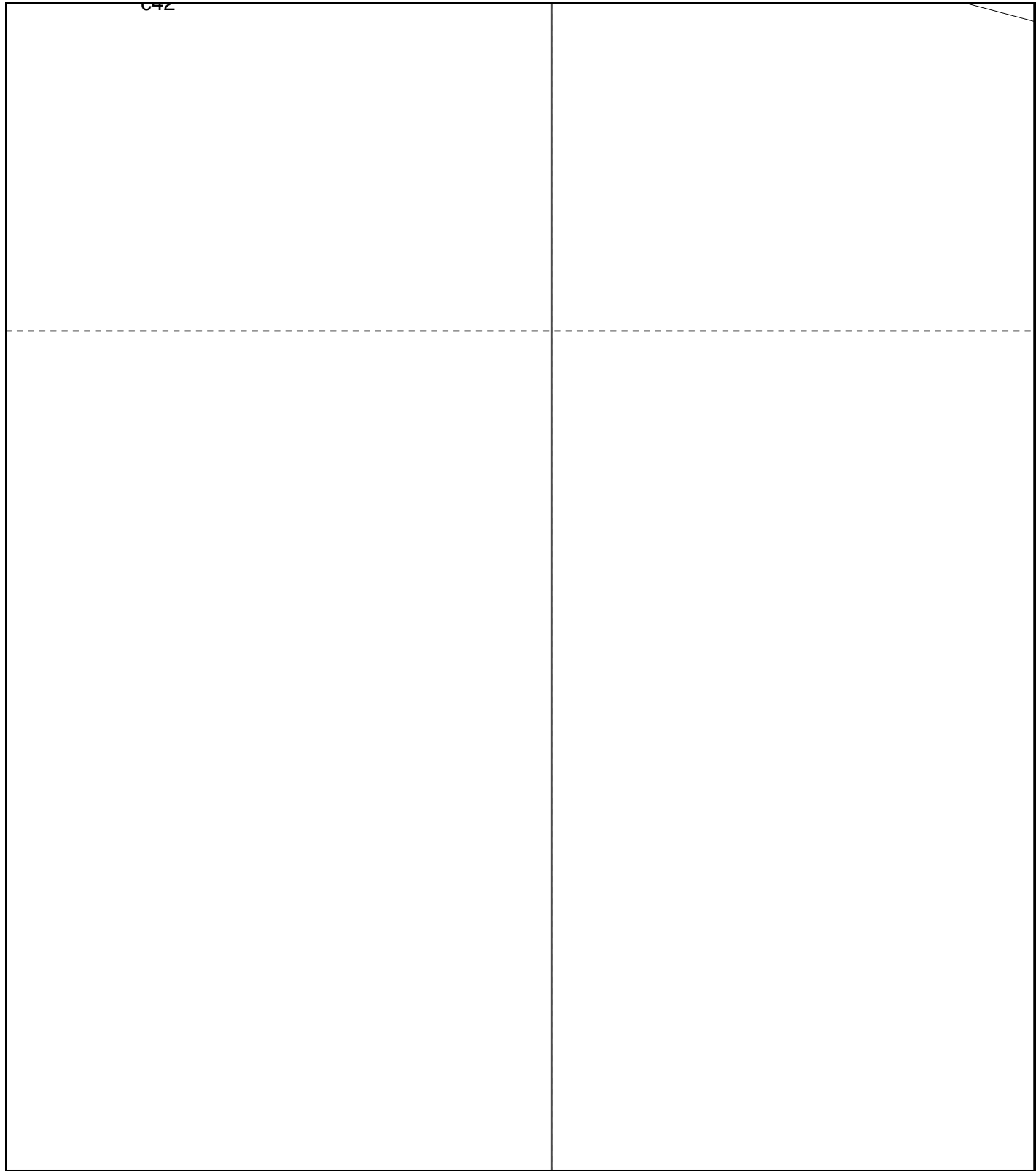

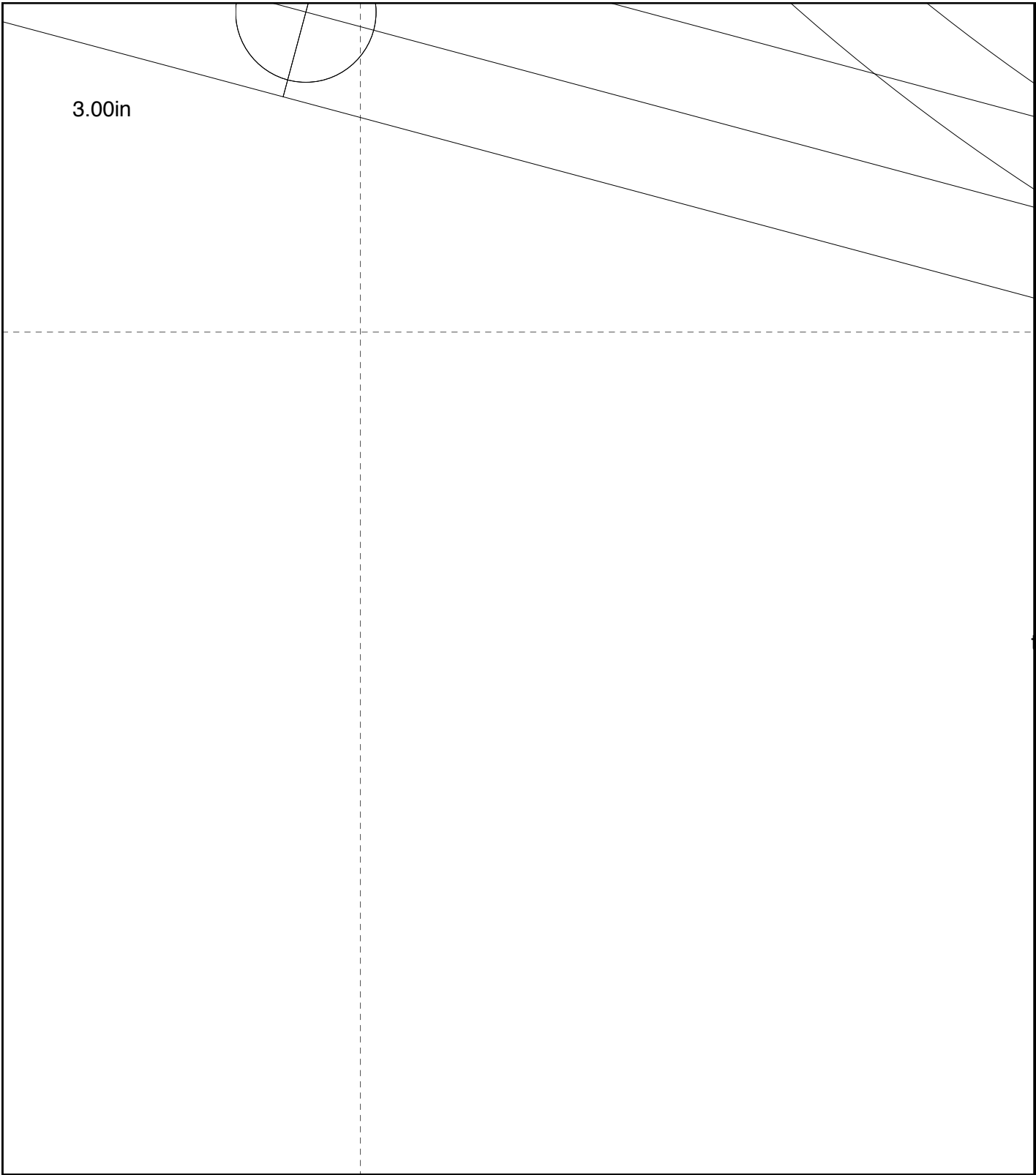

3.00in

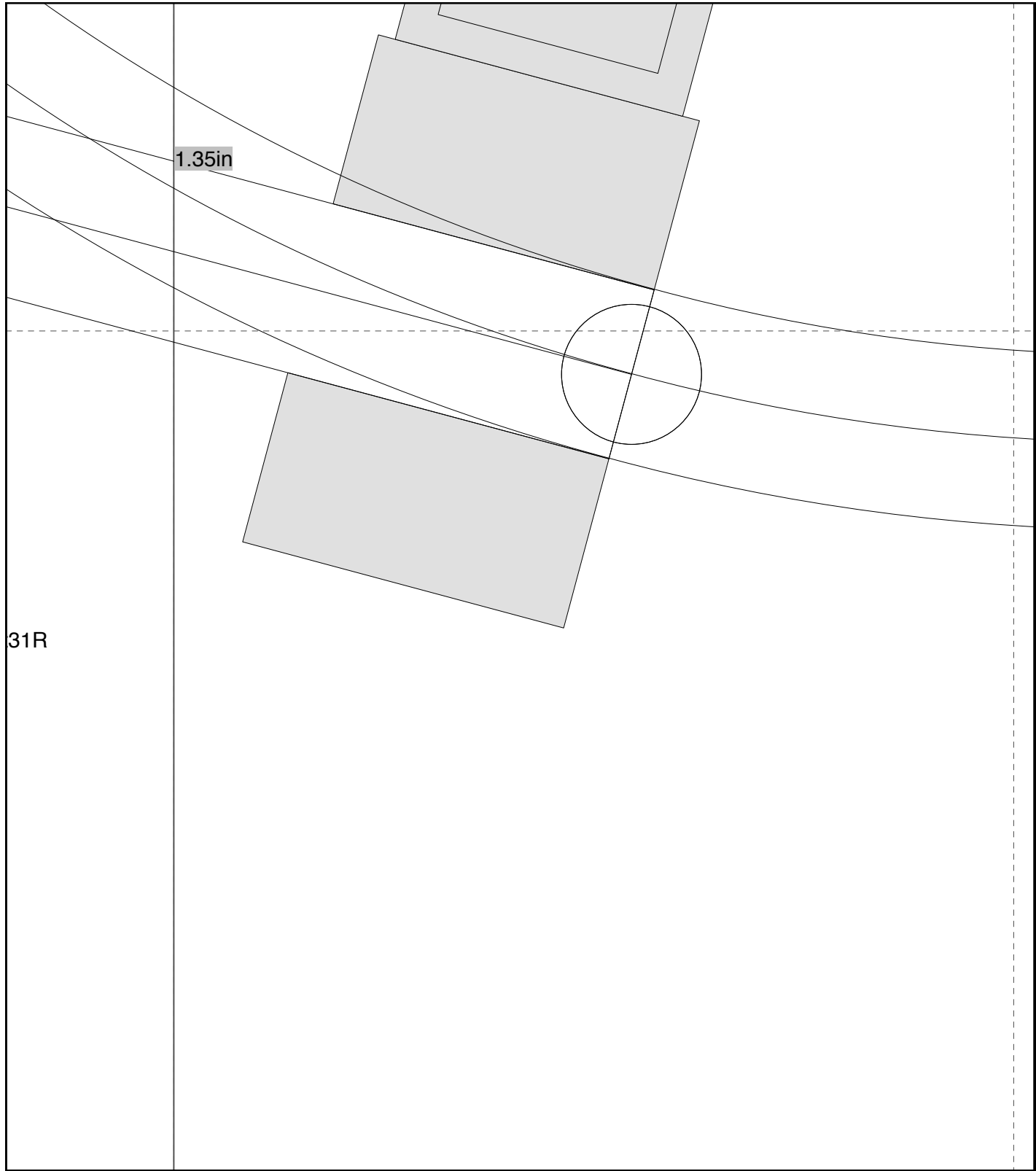

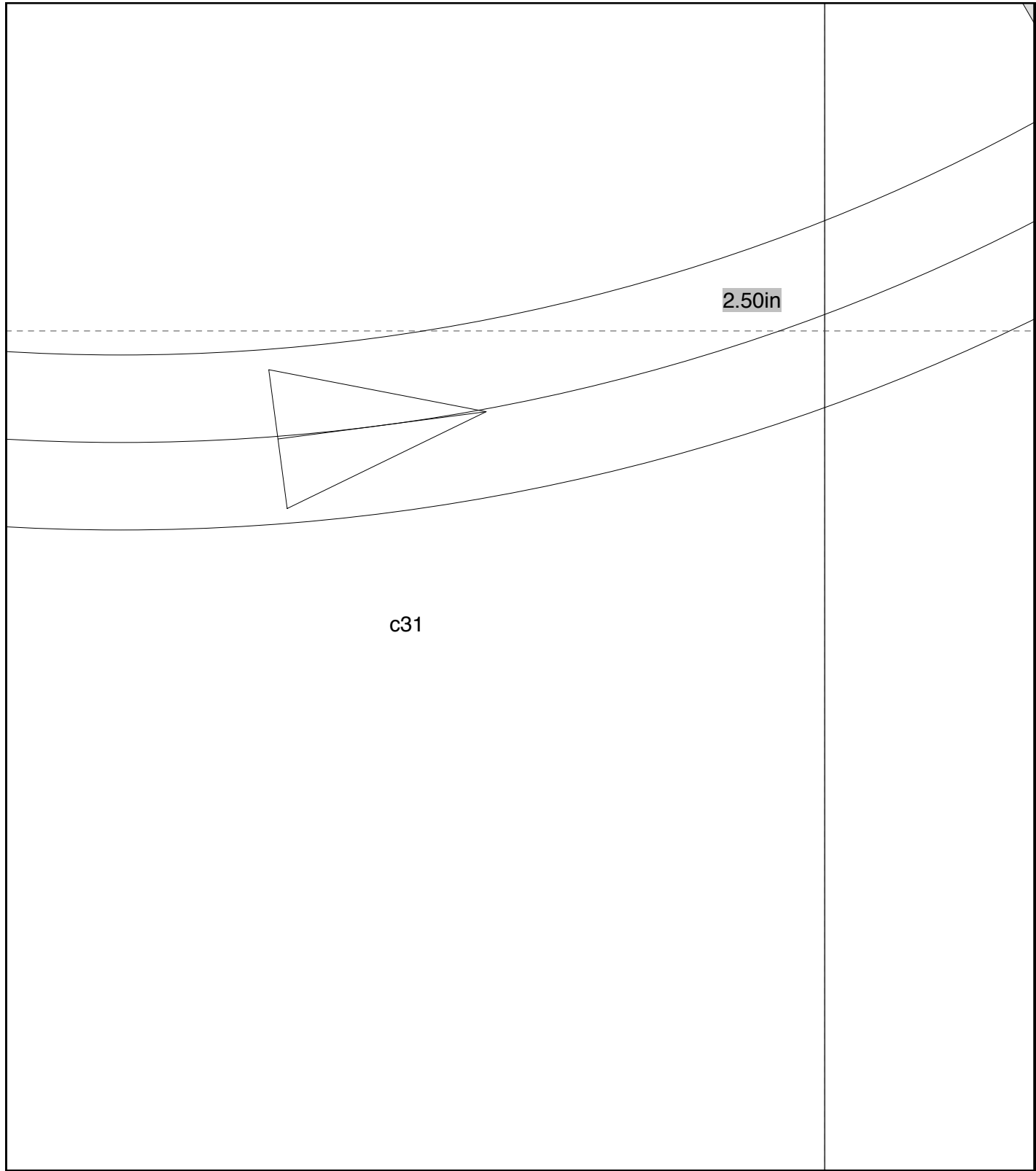

c31

2.50in

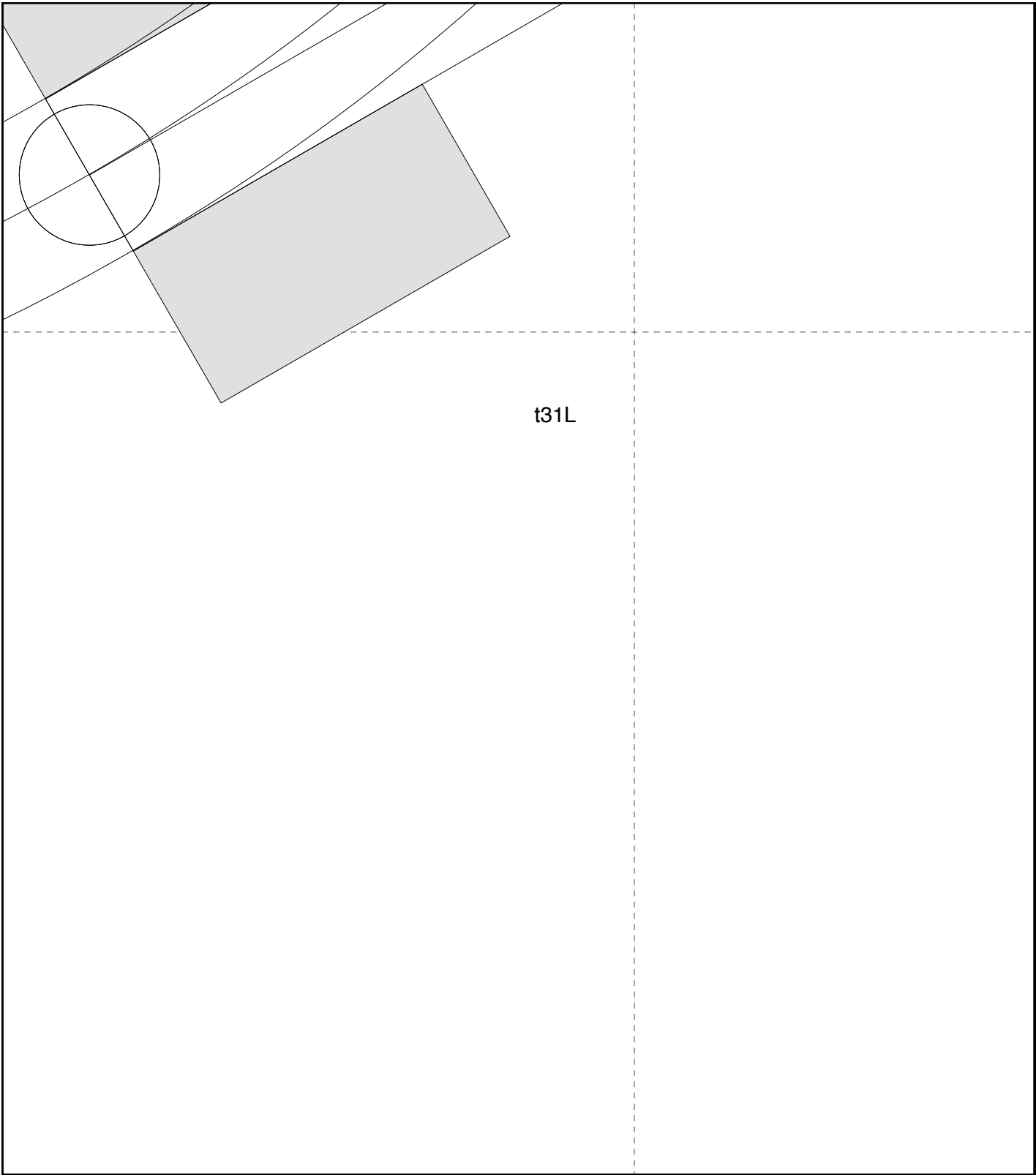

t31L

